

MITSUBISHI IGBT MODULES
CM1400DUC-24NF
 HIGH POWER SWITCHING USE
 INSULATED TYPE

CM1400DUC-24NF

- MPD series using 5th Generation IGBT and FWDi -



Dual switch (Half-Bridge)

- I_C 1400 A
- V_{CES} 1200 V
- Flat base Type
- Copper (non-plating) base plate
- RoHS Directive compliant

● UL Recognized under UL1557, File E323585

APPLICATION

AC Motor Control, Motion/Servo Control, Power supply, etc.

OUTLINE DRAWING & INTERNAL CONNECTION

Dimension in mm

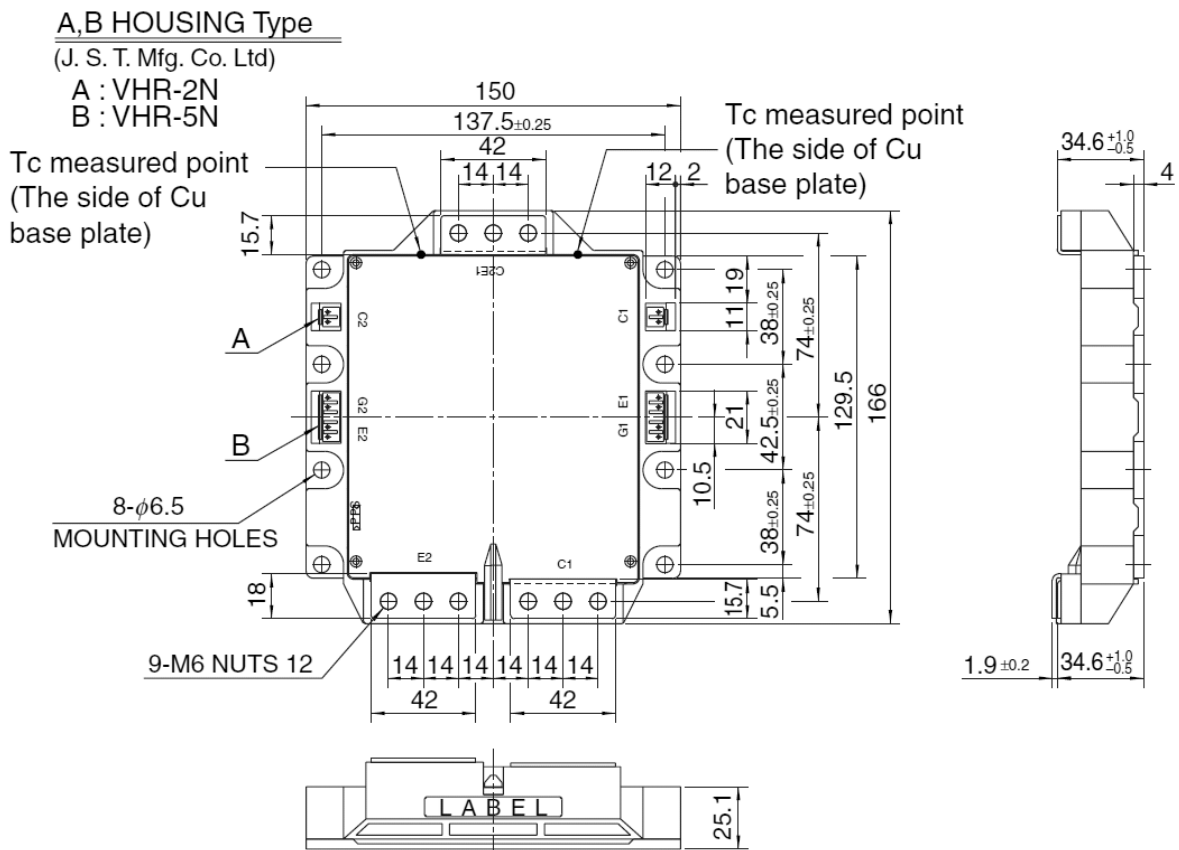

INTERNAL CONNECTION

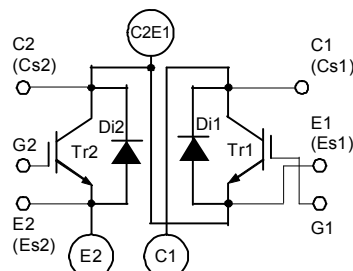

Tolerance otherwise specified	
Division of Dimension	Tolerance
0.5 to 3	±0.2
over 3 to 6	±0.3
over 6 to 30	±0.5
over 30 to 120	±0.8
over 120 to 400	±1.2

MITSUBISHI IGBT MODULES
CM1400DUC-24NF
HIGH POWER SWITCHING USE
INSULATED TYPE

ABSOLUTE MAXIMUM RATINGS ($T_j=25\text{ }^\circ\text{C}$, unless otherwise specified)

Symbol	Item	Conditions	Rating	Unit
V_{CES}	Collector-emitter voltage	G-E short-circuited	1200	V
V_{GES}	Gate-emitter voltage	C-E short-circuited	± 20	V
I_C	Collector current	DC, $T_C=94\text{ }^\circ\text{C}$ (Note2)	1400	A
I_{CRM}		Pulse, Repetitive (Note3)	2800	
P_{tot}	Total power dissipation	$T_C=25\text{ }^\circ\text{C}$ (Note2, 4)	8925	W
I_E (Note1)	Emitter current	$T_C=25\text{ }^\circ\text{C}$ (Note2, 4)	1400	A
I_{ERM} (Note1)	(Free wheeling diode forward current)	Pulse, Repetitive (Note3)	2800	
V_{isol}	Isolation voltage	Terminals to base plate, RMS, $f=60\text{ Hz}$, AC 1 min	2500	V
T_j	Junction temperature	-	$-40 \sim +150$	$^\circ\text{C}$
T_{stg}	Storage temperature	(Note7)	$-40 \sim +125$	

ELECTRICAL CHARACTERISTICS ($T_j=25\text{ }^\circ\text{C}$, unless otherwise specified)

Symbol	Item	Conditions	Limits			Unit	
			Min.	Typ.	Max.		
I_{CES}	Collector-emitter cut-off current	$V_{CE}=V_{CES}$, G-E short-circuited	-	-	1	mA	
I_{GES}	Gate-emitter leakage current	$V_{GE}=V_{GES}$, C-E short-circuited	-	-	1.5	μA	
$V_{GE(th)}$	Gate-emitter threshold voltage	$I_C=140\text{ mA}$, $V_{CE}=10\text{ V}$	6	7	8	V	
V_{CEsat}	Collector-emitter saturation voltage	$I_C=1400\text{ A}$ (Note5), $V_{GE}=15\text{ V}$	$T_j=25\text{ }^\circ\text{C}$	-	1.8	2.5	V
			$T_j=125\text{ }^\circ\text{C}$	-	2.0	-	
C_{ies}	Input capacitance	$V_{CE}=10\text{ V}$, G-E short-circuited	-	-	220	nF	
C_{oes}	Output capacitance		-	-	25		
C_{res}	Reverse transfer capacitance		-	-	4.7		
Q_G	Gate charge	$V_{CC}=600\text{ V}$, $I_C=1400\text{ A}$, $V_{GE}=15\text{ V}$	-	7200	-	nC	
$t_{d(on)}$	Turn-on delay time	$V_{CC}=600\text{ V}$, $I_C=1400\text{ A}$, $V_{GE}=\pm 15\text{ V}$, $R_G=0.22\text{ }\Omega$, Inductive load	-	-	800	ns	
t_r	Rise time		-	-	300		
$t_{d(off)}$	Turn-off delay time		-	-	1000		
t_f	Fall time		-	-	300		
V_{EC} (Note1)	Emitter-collector voltage	$I_E=1400\text{ A}$, G-E short-circuited (Note5)	-	2.5	3.2	V	
t_{rr} (Note1)	Reverse recovery time	$V_{CC}=600\text{ V}$, $I_E=1400\text{ A}$, $V_{GE}=\pm 15\text{ V}$, $R_G=0.22\text{ }\Omega$, Inductive load	-	-	700	ns	
Q_{rr} (Note1)	Reverse recovery charge	$R_G=0.22\text{ }\Omega$, Inductive load	-	90	-	μC	
E_{on}	Turn-on switching energy per pulse	$V_{CC}=600\text{ V}$, $I_C=I_E=1400\text{ A}$, $V_{GE}=\pm 15\text{ V}$, $R_G=0.22\text{ }\Omega$, $T_j=125\text{ }^\circ\text{C}$, Inductive load	-	122.8	-	mJ	
E_{off}	Turn-off switching energy per pulse		-	161.2	-		
E_{rr} (Note1)	Reverse recovery energy per pulse		-	136.9	-		
R_{CC+EE}	Internal lead resistance	Main terminals-chip, per switch, $T_C=25\text{ }^\circ\text{C}$ (Note2)	-	0.286	-	m Ω	
r_g	Internal gate resistance	Per switch	-	1.0	-	Ω	

THERMAL RESISTANCE CHARACTERISTICS

Symbol	Item	Conditions	Limits			Unit
			Min.	Typ.	Max.	
$R_{th(j-c)Q}$	Thermal resistance (Note2)	Junction to case, per IGBT	-	-	14	K/kW
$R_{th(j-c)D}$		Junction to case, per FWDi	-	-	23	
$R_{th(c-s)}$	Contact thermal resistance (Note2)	Case to heat sink, per 1/2 module, Thermal grease applied (Note6)	-	12	-	K/kW

MECHANICAL CHARACTERISTICS

Symbol	Item	Conditions	Limits			Unit
			Min.	Typ.	Max.	
M_t	Mounting torque	Main terminals M 6 screw	3.5	4.0	4.5	N·m
M_s		Mounting to heat sink M 6 screw	3.5	4.0	4.5	
m	Weight	-	-	1450	-	g
e_c	Flatness of base plate	On the centerline X, Y1, Y2 (Note8)	-50	-	+100	μm

MITSUBISHI IGBT MODULES
CM1400DUC-24NF
HIGH POWER SWITCHING USE
INSULATED TYPE

RECOMMENDED OPERATING CONDITIONS

Symbol	Item	Conditions	Limits			Unit
			Min.	Typ.	Max.	
V_{CC}	(DC) Supply voltage	Applied across C1-E2	-	600	800	V
V_{GEon}	Gate (-emitter drive) voltage	Applied across G1-Es1/G2-Es2	13.5	15.0	16.5	
R_G	External gate resistance	Per switch	0.22	-	2.2	Ω

- Note1. Represent ratings and characteristics of the anti-parallel, emitter-collector free wheeling diode (FWDi).
- Case temperature (T_c) and heat sink temperature (T_s) are defined on the each surface of base plate and heat sink just under the chips. (Refer to the figure of chip location)
The heat sink thermal resistance $\{R_{th(s-a)}\}$ should measure just under the chips.
 - Pulse width and repetition rate should be such that the device junction temperature (T_j) dose not exceed T_{jmax} rating.
 - Junction temperature (T_j) should not increase beyond T_{jmax} rating.
 - Pulse width and repetition rate should be such as to cause negligible temperature rise. (Refer to the figure of test circuit)
 - Typical value is measured by using thermally conductive grease of $\lambda=0.9$ W/(m·K).
 - The operation temperature is restrained by the permission temperature of female connector housing.
 - Base plate flatness measurement points are as in the following figure.

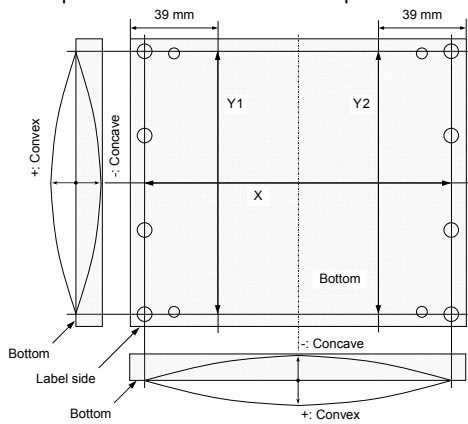

- Generally, the company name, the brand name listed in this material are the trademark of the companies or registered trademarks.

MITSUBISHI IGBT MODULES
CM1400DUC-24NF
 HIGH POWER SWITCHING USE
 INSULATED TYPE

CHIP LOCATION (Top view)

Dimension in mm, tolerance: ± 1 mm

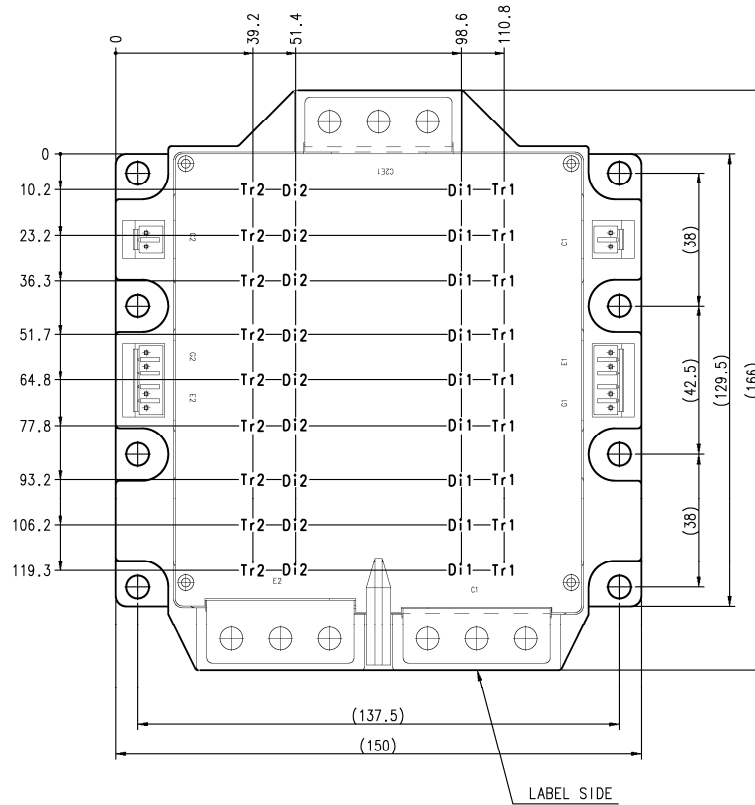

Tr1/Tr2: IGBT, Di1/Di2: FWDi. Each mark points the center position of each chip.

TEST CIRCUIT AND WAVEFORMS

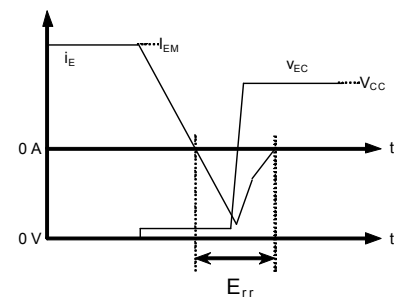
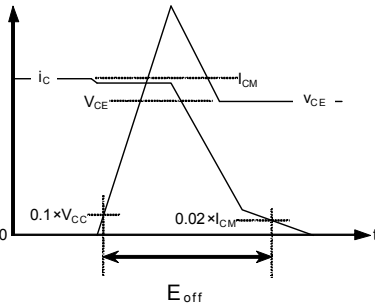
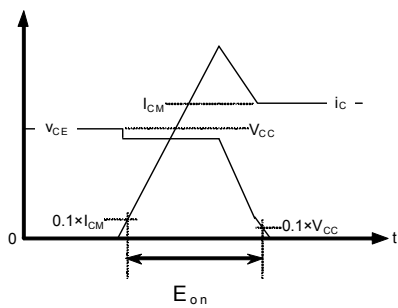
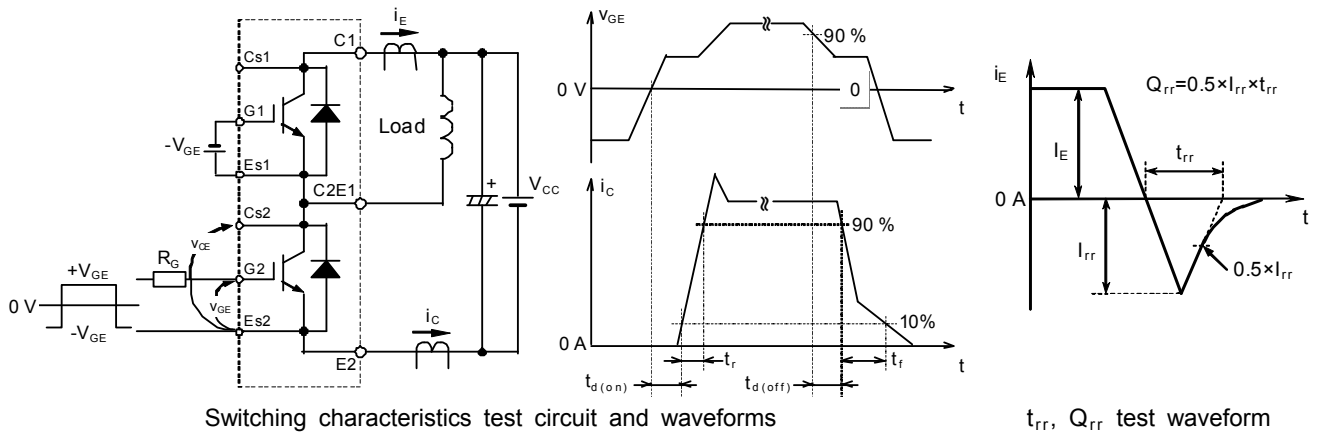
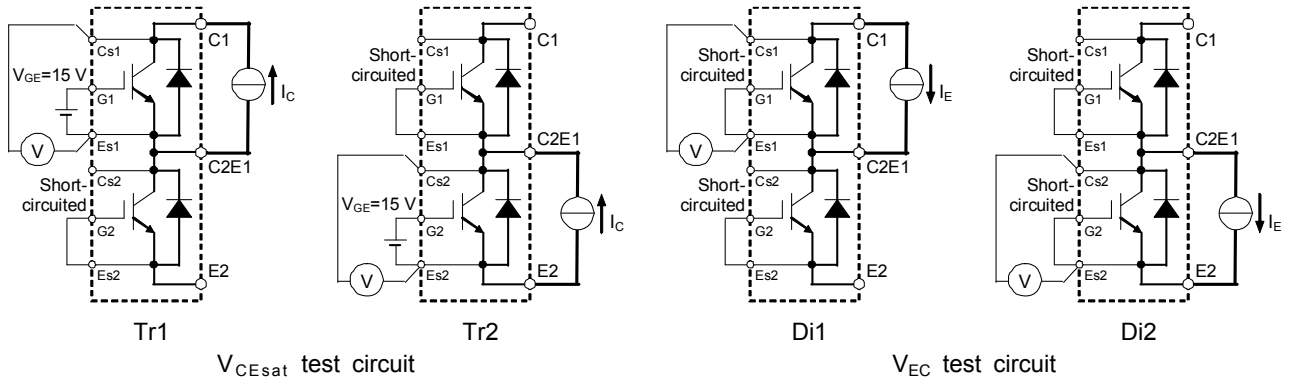

Turn-on / Turn-off switching energy and Reverse recovery energy integral range

PERFORMANCE CURVES

OUTPUT CHARACTERISTICS
 (TYPICAL)

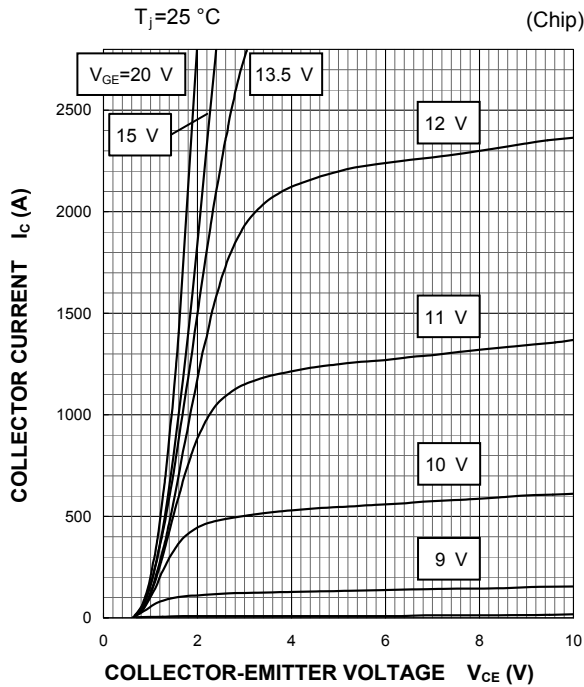

COLLECTOR-EMITTER SATURATION
 VOLTAGE CHARACTERISTICS
 (TYPICAL)

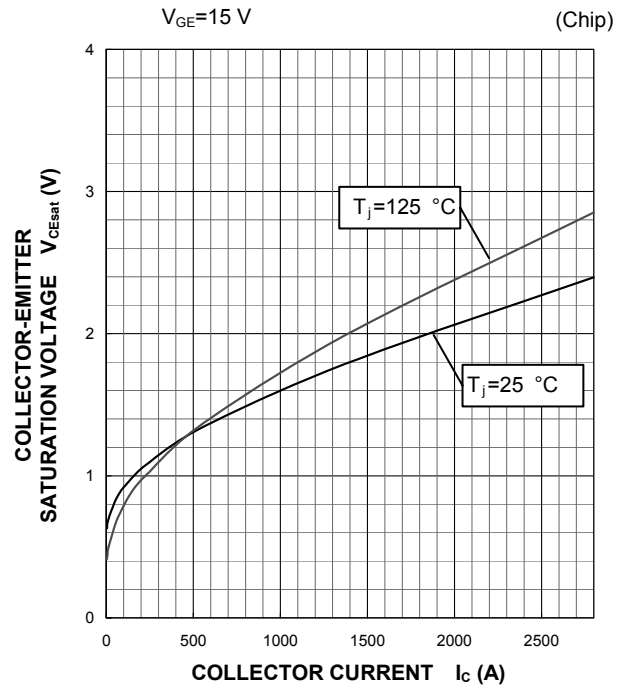

COLLECTOR-EMITTER SATURATION
 VOLTAGE CHARACTERISTICS
 (TYPICAL)

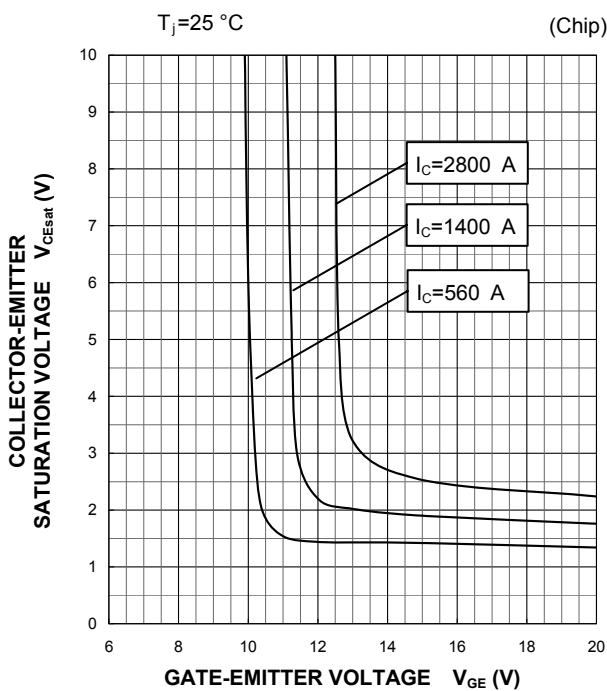

FREE WHEELING DIODE
 FORWARD CHARACTERISTICS
 (TYPICAL)

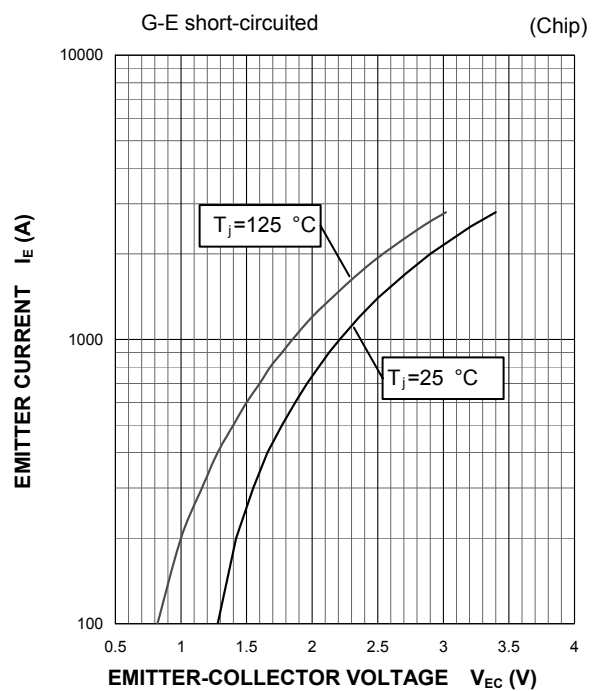

MITSUBISHI IGBT MODULES
CM1400DUC-24NF
 HIGH POWER SWITCHING USE
 INSULATED TYPE

**HALF-BRIDGE
 SWITCHING CHARACTERISTICS
 (TYPICAL)**

$V_{CC}=600\text{ V}$, $V_{GE}=\pm 15\text{ V}$, $R_G=0.22\ \Omega$, $T_J=125\text{ }^\circ\text{C}$,
 INDUCTIVE LOAD

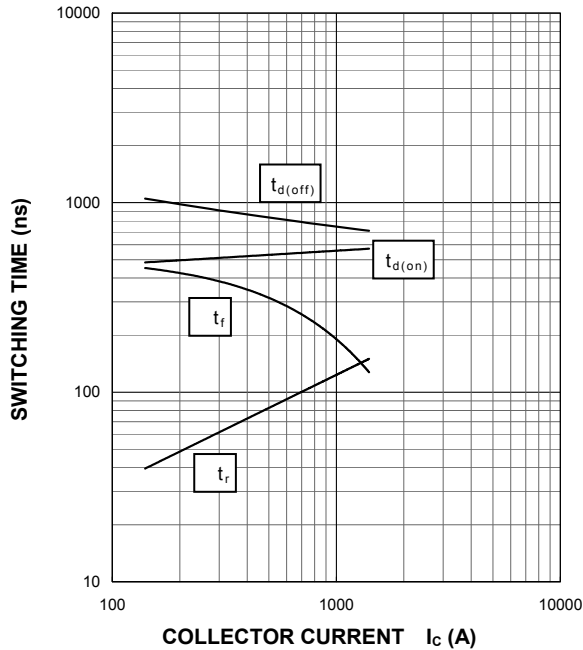

**HALF-BRIDGE
 SWITCHING CHARACTERISTICS
 (TYPICAL)**

$V_{CC}=600\text{ V}$, $I_C=1400\text{ A}$, $V_{GE}=\pm 15\text{ V}$, $T_J=125\text{ }^\circ\text{C}$,
 INDUCTIVE LOAD

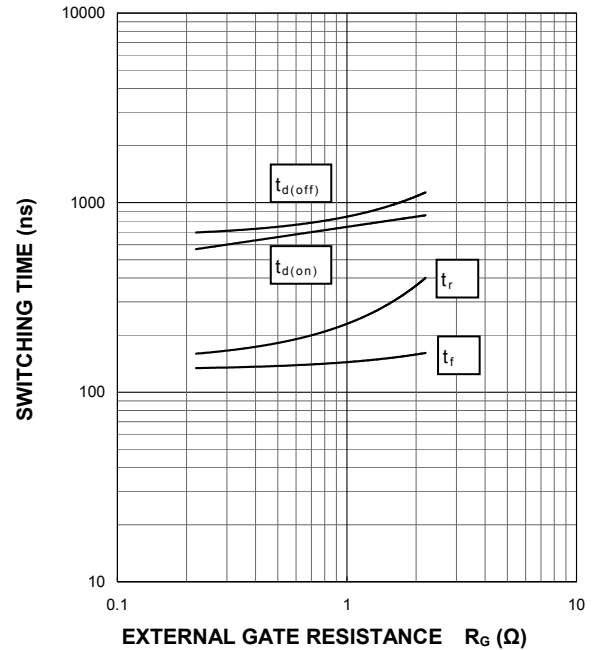

**HALF-BRIDGE
 SWITCHING CHARACTERISTICS
 (TYPICAL)**

$V_{CC}=600\text{ V}$, $V_{GE}=\pm 15\text{ V}$, $R_G=0.22\ \Omega$, $T_J=125\text{ }^\circ\text{C}$,
 INDUCTIVE LOAD, PER PULSE

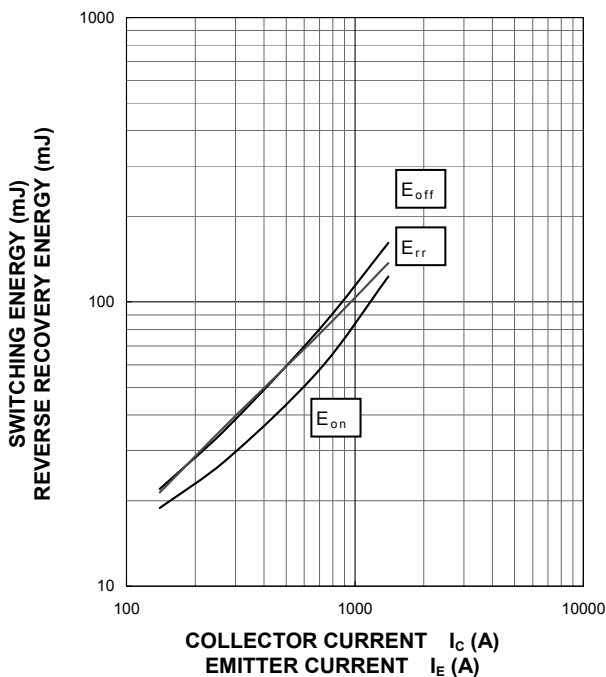

**HALF-BRIDGE
 SWITCHING CHARACTERISTICS
 (TYPICAL)**

$V_{CC}=600\text{ V}$, $I_C/I_E=1400\text{ A}$, $V_{GE}=\pm 15\text{ V}$, $T_J=125\text{ }^\circ\text{C}$,
 INDUCTIVE LOAD, PER PULSE

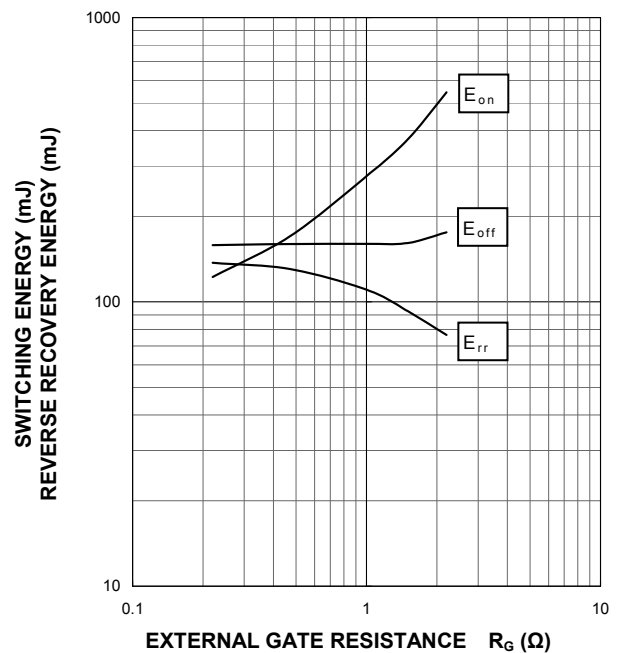

MITSUBISHI IGBT MODULES
CM1400DUC-24NF
 HIGH POWER SWITCHING USE
 INSULATED TYPE

**CAPACITANCE CHARACTERISTICS
 (TYPICAL)**

G-E short-circuited, $T_j=25\text{ }^\circ\text{C}$

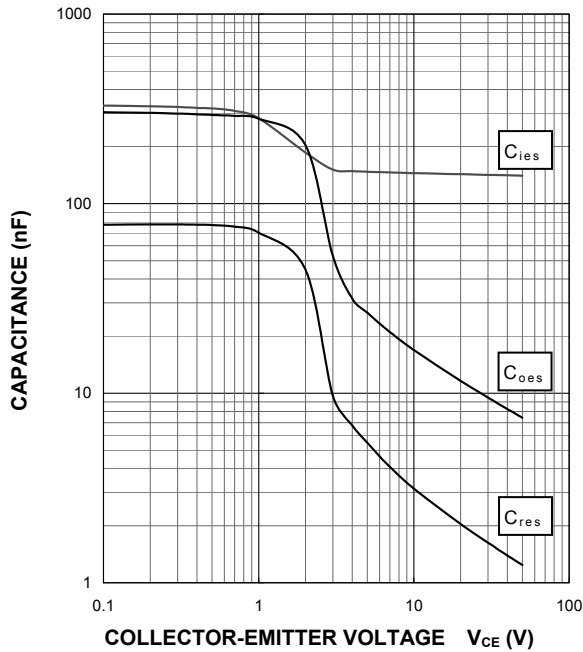

**FREE WHEELING DIODE
 REVERSE RECOVERY CHARACTERISTICS
 (TYPICAL)**

$V_{CC}=600\text{ V}$, $V_{GE}=\pm 15\text{ V}$, $R_G=0.22\text{ }\Omega$, $T_j=25\text{ }^\circ\text{C}$,
 INDUCTIVE LOAD

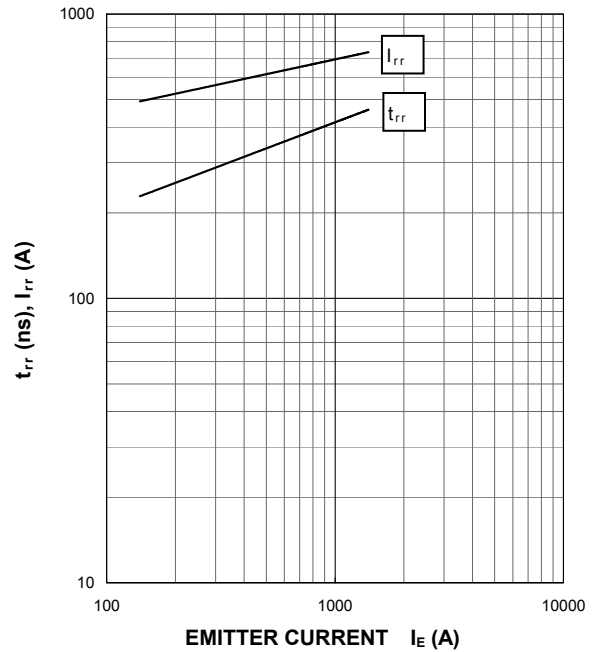

**GATE CHARGE CHARACTERISTICS
 (TYPICAL)**

$I_c=1400\text{ A}$, $T_j=25\text{ }^\circ\text{C}$

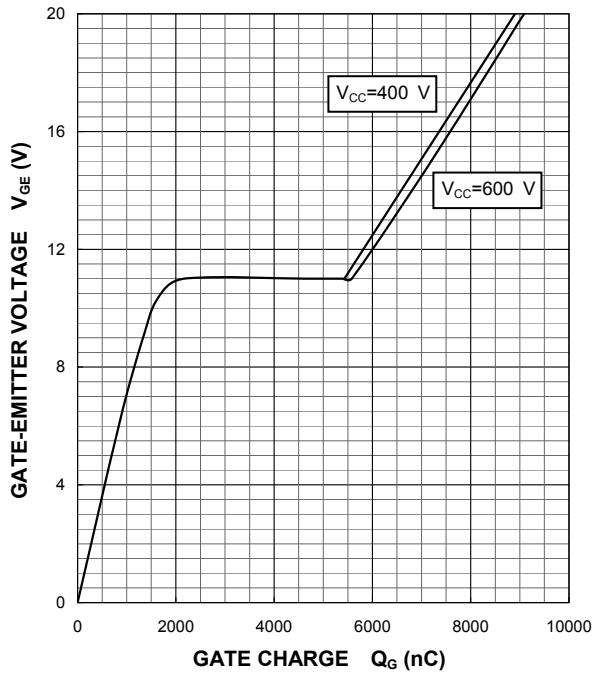

**TRANSIENT THERMAL IMPEDANCE
 CHARACTERISTICS
 (MAXIMUM)**

Single pulse, $T_c=25\text{ }^\circ\text{C}$

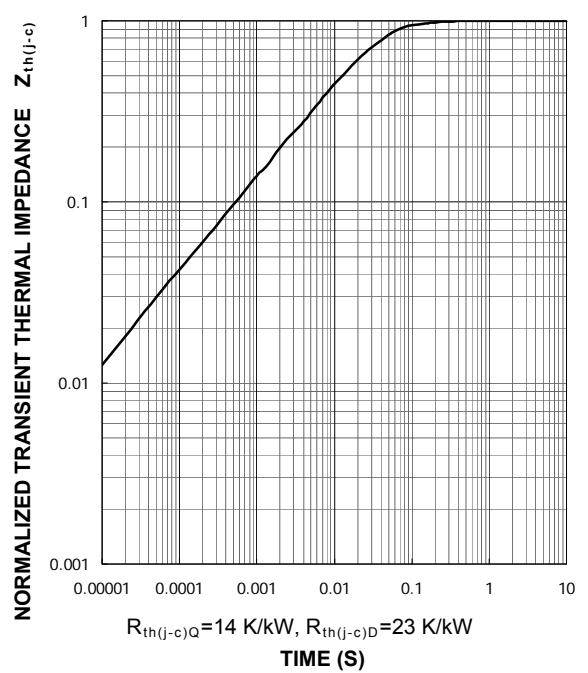

Keep safety first in your circuit designs!

·Mitsubishi Electric Corporation puts the maximum effort into making semiconductor products better and more reliable, but there is always the possibility that trouble may occur with them. Trouble with semiconductors may lead to personal injury, fire or property damage.

Remember to give due consideration to safety when making your circuit designs, with appropriate measures such as (i) placement of substitutive, auxiliary circuits, (ii) use of non-flammable material or (iii) prevention against any malfunction or mishap.

Notes regarding these materials

·These materials are intended as a reference to assist our customers in the selection of the Mitsubishi semiconductor product best suited to the customer's application; they do not convey any license under any intellectual property rights, or any other rights, belonging to Mitsubishi Electric Corporation or a third party.

·Mitsubishi Electric Corporation assumes no responsibility for any damage, or infringement of any third-party's rights, originating in the use of any product data, diagrams, charts, programs, algorithms, or circuit application examples contained in these materials.

·All information contained in these materials, including product data, diagrams, charts, programs and algorithms represents information on products at the time of publication of these materials, and are subject to change by Mitsubishi Electric Corporation without notice due to product improvements or other reasons. It is therefore recommended that customers contact Mitsubishi Electric Corporation or an authorized Mitsubishi Semiconductor product distributor for the latest product information before purchasing a product listed herein.

The information described here may contain technical inaccuracies or typographical errors. Mitsubishi Electric Corporation assumes no responsibility for any damage, liability, or other loss rising from these inaccuracies or errors.

Please also pay attention to information published by Mitsubishi Electric Corporation by various means, including the Mitsubishi Semiconductor home page (<http://www.mitsubishichips.com/Global/index.html>).

·When using any or all of the information contained in these materials, including product data, diagrams, charts, programs, and algorithms, please be sure to evaluate all information as a total system before making a final decision on the applicability of the information and products. Mitsubishi Electric Corporation assumes no responsibility for any damage, liability or other loss resulting from the information contained herein.

·Mitsubishi Electric Corporation semiconductors are not designed or manufactured for use in a device or system that is used under circumstances in which human life is potentially at stake. Please contact Mitsubishi Electric Corporation or an authorized Mitsubishi Semiconductor product distributor when considering the use of a product contained herein for any specific purposes, such as apparatus or systems for transportation, vehicular, medical, aerospace, nuclear, or undersea repeater use.

·The prior written approval of Mitsubishi Electric Corporation is necessary to reprint or reproduce in whole or in part these materials.

·If these products or technologies are subject to the Japanese export control restrictions, they must be exported under a license from the Japanese government and cannot be imported into a country other than the approved destination.

Any diversion or reexport contrary to the export control laws and regulations of Japan and/or the country of destination is prohibited.

·Please contact Mitsubishi Electric Corporation or an authorized Mitsubishi Semiconductor product distributor for further details on these materials or the products contained therein.