

600V / 10A 6 in one-package

■ Features

- Compact Single in -line package

■ Applications

- Inverter for Motor drive
- AC and DC Servo drive amplifier
- Uninterruptible power supply
- Industrial machines, such as Welding machines

■ Maximum ratings and characteristics

● Absolute maximum ratings (at Tc=25°C unless otherwise specified)

Item	Symbol	Rating	Unit
Collector-Emitter voltage	V _{CES}	600	V
Gate-Emitter voltage	V _{GES}	±20	V
Collector current	Continuous	I _C	10 A
	1ms	I _C pulse	20 A
		-I _C	10 A
	1ms	-I _C pulse	20 A
Max. power dissipation	P _C	45	W
Operating temperature	T _j	+150	°C
Storage temperature	T _{stg}	-40 to +125	°C
Isolation voltage	V _{is}	AC 2000 (1min.)	V
Screw torque	Mounting *1	1.7	N·m

*1 : Recommendable value : 1.3 to 1.7 N·m (M4)

● Electrical characteristics (at Tj=25°C unless otherwise specified)

Item	Symbol	Characteristics			Conditions	Unit
		Min.	Typ.	Max.		
Zero gate voltage collector current	I _{CES}	-	-	1.0	V _{GE} =0V, V _{CES} =600V	mA
Gate-Emitter leakage current	I _{GES}	-	-	0.1	V _{CE} =0V, V _{GE} =±20V	µA
Gate-Emitter threshold voltage	V _{GE(th)}	5.5	-	8.5	V _{CE} =20V, I _C =10mA	V
Collector-Emitter saturation voltage	V _{CE(sat)}	-	-	2.8	V _{GE} =15V, I _C =10A	V
Input capacitance	C _{ies}	-	650	-	V _{GE} =0V	pF
Output capacitance	C _{oes}	-	150	-	V _{CE} =10V	
Reverse transfer capacitance	C _{res}	-	36	-	f=1MHz	
Turn-on time	t _{on}	-	-	1.2	V _{CC} =300V	µs
	t _r	-	-	1.0	I _C =10A	
Turn-off time	t _{off}	-	-	1.0	V _{GE} =±15V	
	t _f	-	-	0.35	R _G =220ohm	
Diode forward on voltage	V _F	-	-	3.0	I _F =10A, V _{GE} =0V	V
Reverse recovery time	t _{rr}	-	-	0.3	I _F =10A, -di/dt=30A/µs, V _{GE} =-10V	µs

● Thermal resistance characteristics

Item	Symbol	Characteristics			Conditions	Unit
		Min.	Typ.	Max.		
Thermal resistance	R _{th(j-c)}	-	-	2.78	IGBT	°C/W
	R _{th(j-c)}	-	-	4.5	Diode	°C/W
	R _{th(c-f)*2}	-	0.06	-	the base to cooling fin	°C/W

*2 : This is the value which is defined mounting on the additional cooling fin with thermal compound



■ Equivalent Circuit Schematic

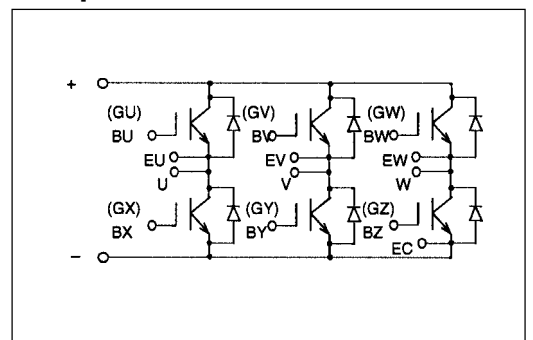

■ Characteristics (Representative)

Collector current vs. Collector-Emitter voltage
T_J=25°C

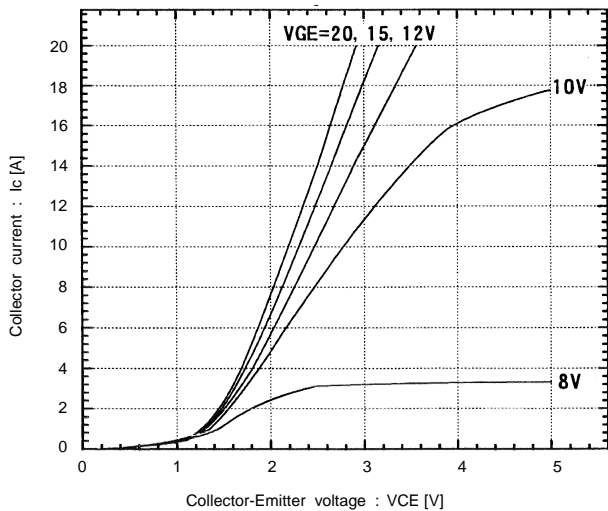

Collector current vs. Collector-Emitter voltage
T_J=125°C

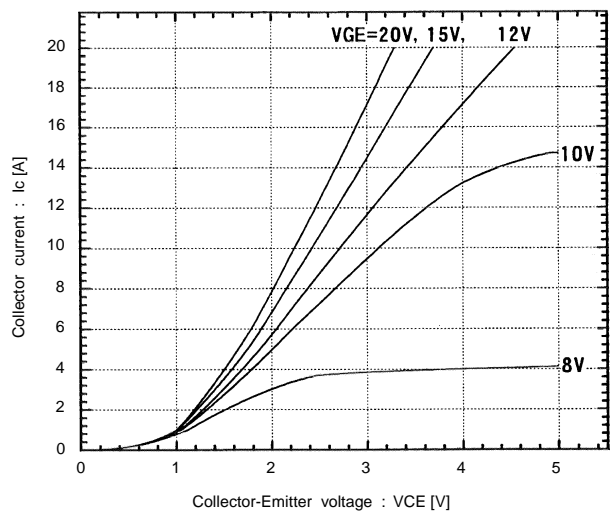

Collector-Emitter vs. Gate-Emitter voltage
T_J=25°C

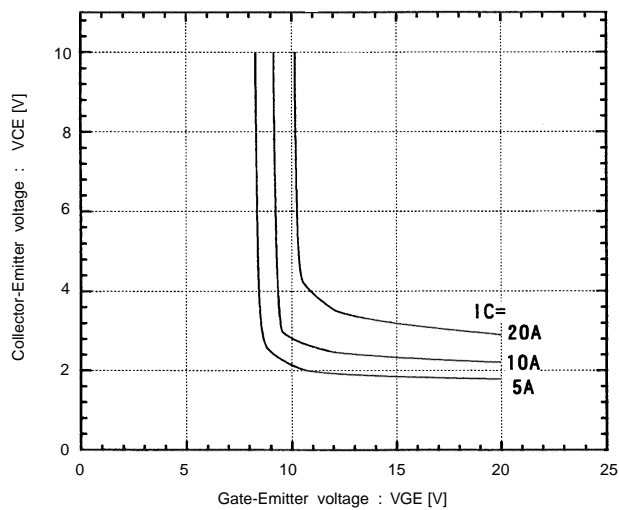

Collector-Emitter vs. Gate-Emitter voltage
T_J=125°C

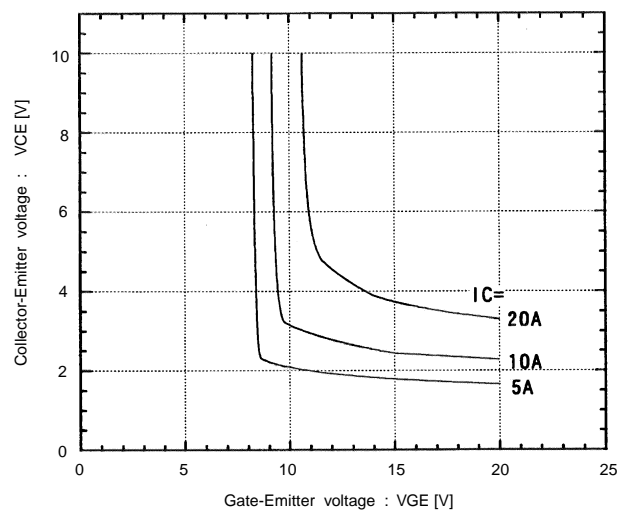

Switching time vs. Collector current
V_{CC}=300V, R_G=220 ohm, V_{GE}=±15V, T_J=25°C

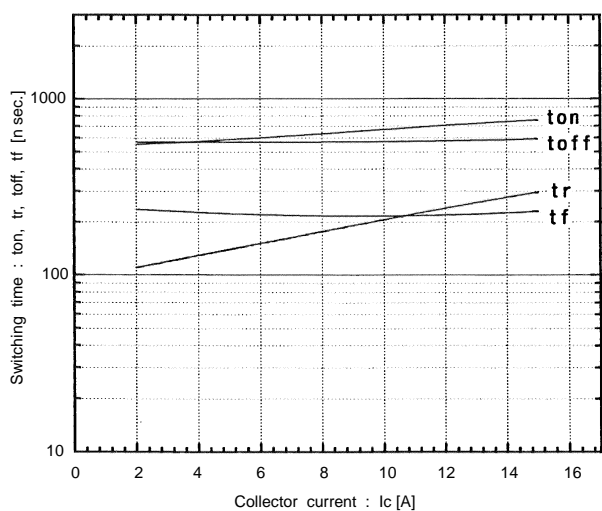

Switching time vs. Collector current
V_{CC}=300V, R_G=220 ohm, V_{GE}=±15V, T_J=125°C

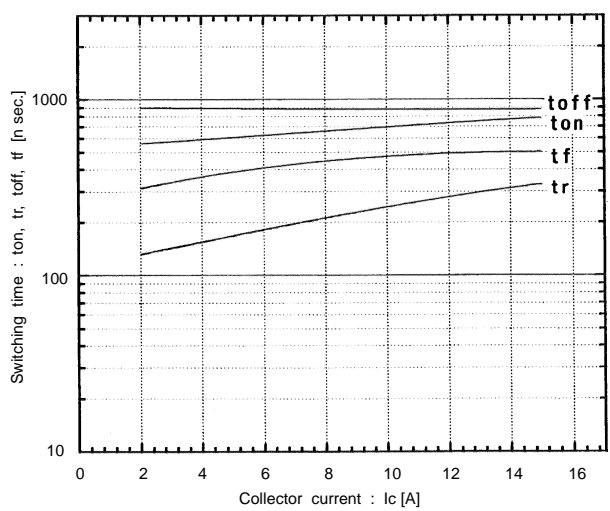

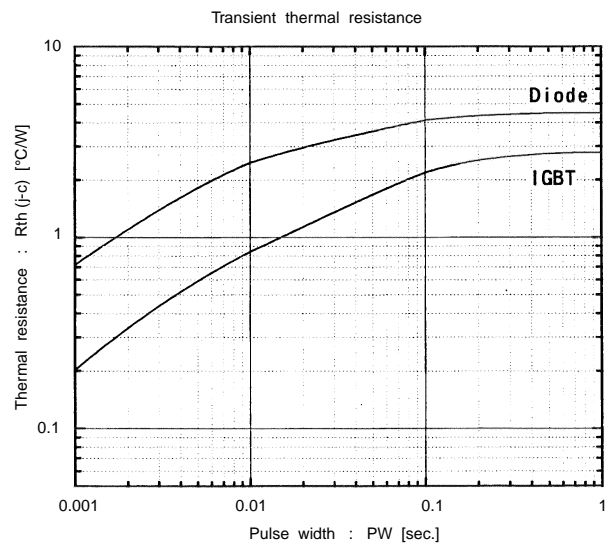
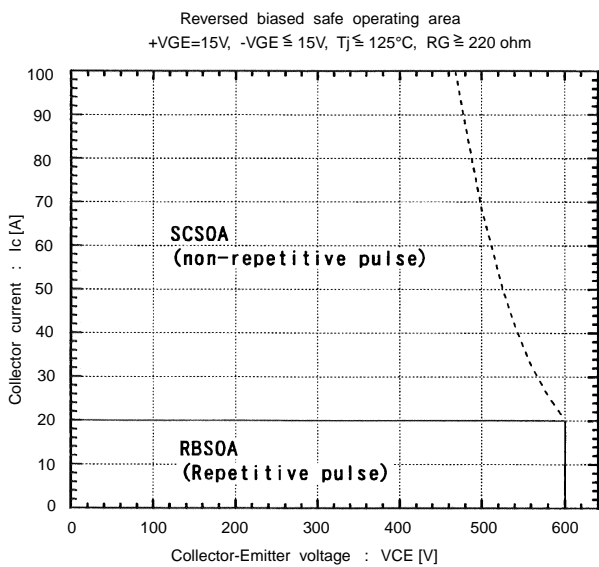
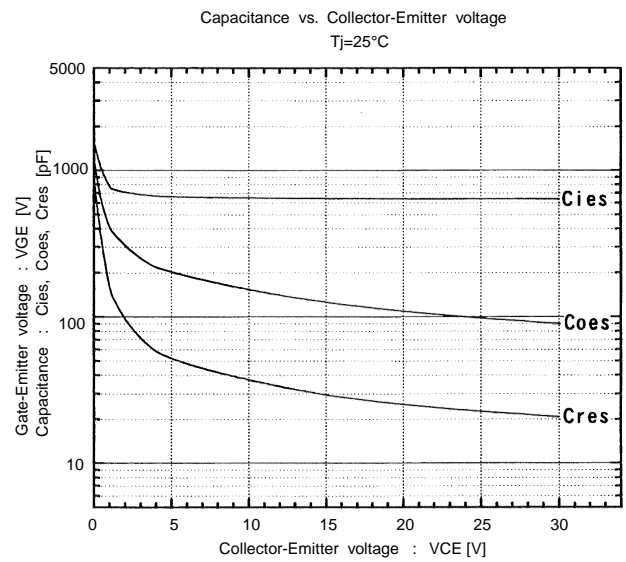
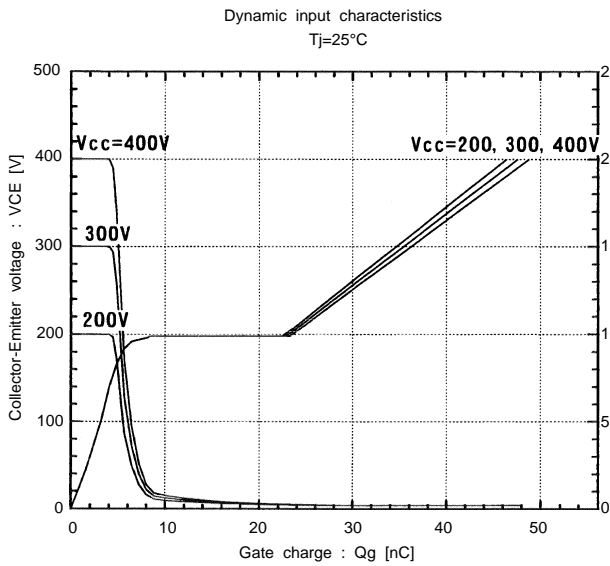
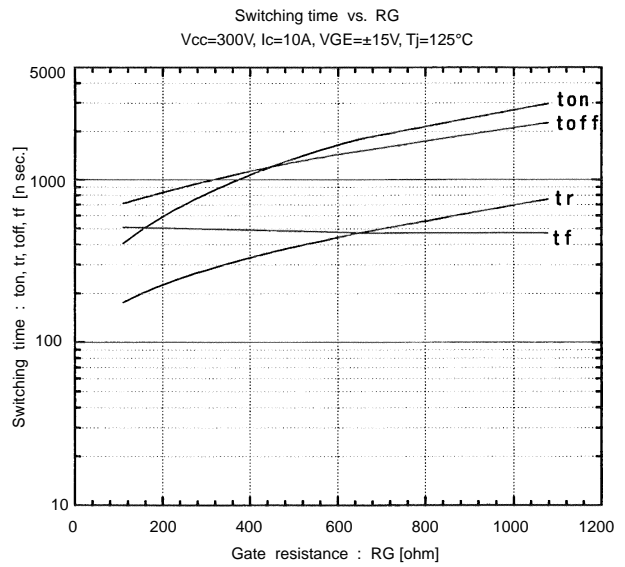
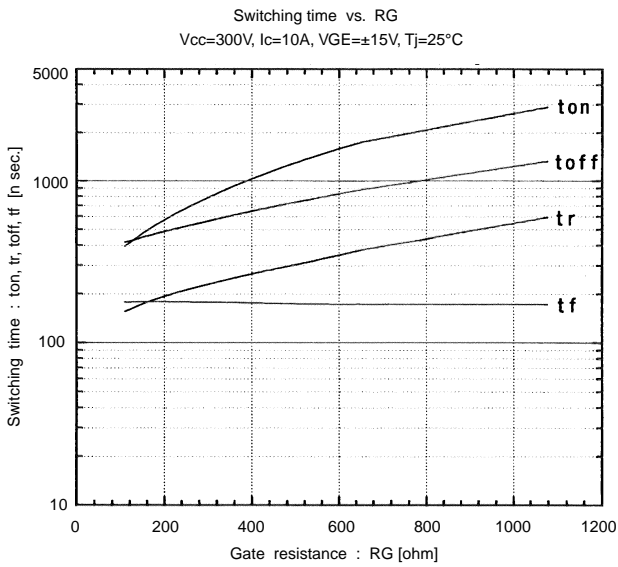

Switching loss vs. Collector current
 $V_{cc}=300V, R_G=220\text{ ohm}, V_{GE}=\pm 15V, T_J=125^\circ C$

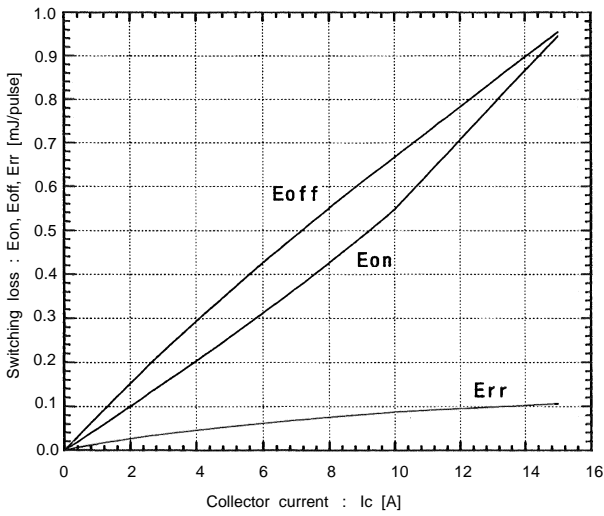

Switching loss vs. Gate resistance
 $V_{cc}=300V, I_c=10A, V_{GE}=\pm 15V, T_J=125^\circ C$

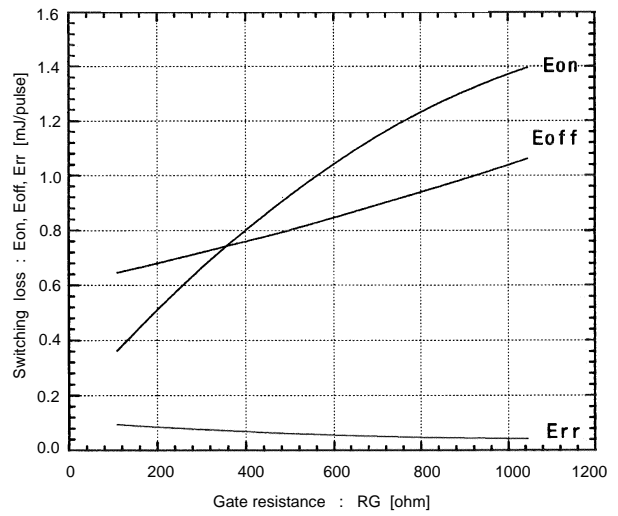

Forward current vs. Forward voltage

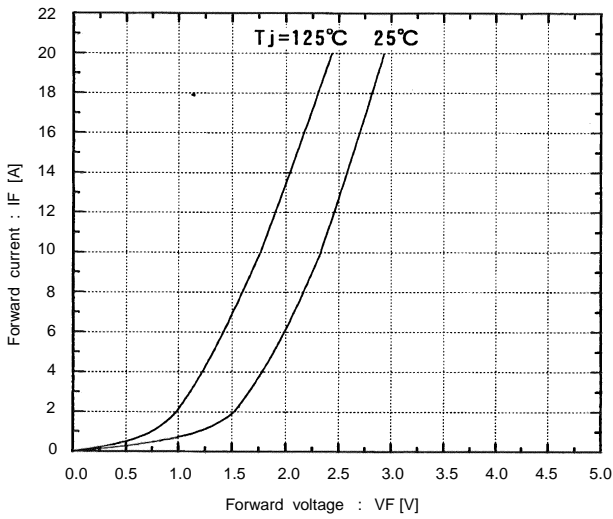

Reverse recovery characteristics
 t_{rr}, I_{rr} , vs. I_F

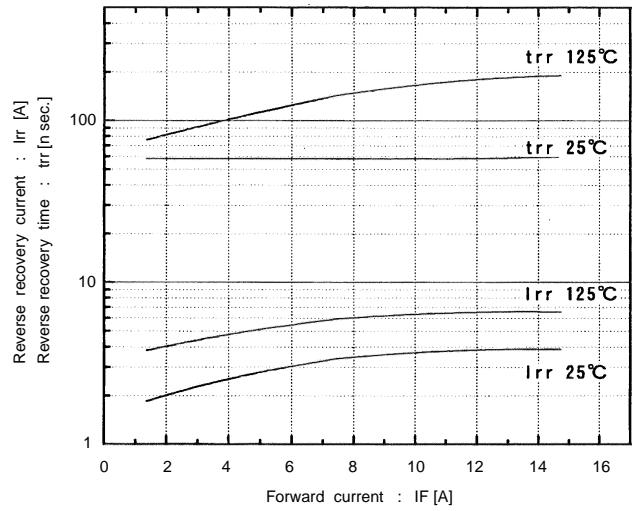

Outline Drawings, mm

