

SEMiX101GD126HDs



SEMiX® 13

Trench IGBT Modules

SEMiX101GD126HDs

Features

- Homogeneous Si
- Trench = Trenchgate technology
- $V_{CE(sat)}$ with positive temperature coefficient
- High short circuit capability
- UL recognised file no. E63532

Typical Applications*

- AC inverter drives
- UPS
- Electronic Welding

Remarks

- Case temperatur limited to $T_C=125^\circ\text{C}$ max.
- Not for new design



GD

Absolute Maximum Ratings				
Symbol	Conditions	Values	Unit	
IGBT				
V_{CES}		1200	V	
I_C	$T_j = 150^\circ\text{C}$	$T_c = 25^\circ\text{C}$	129	A
		$T_c = 80^\circ\text{C}$	91	A
I_{Cnom}		75	A	
I_{CRM}	$I_{CRM} = 2 \times I_{Cnom}$	150	A	
V_{GES}		-20 ... 20	V	
t_{psc}	$V_{CC} = 600\text{ V}$ $V_{GE} \leq 20\text{ V}$ $V_{CES} \leq 1200\text{ V}$	$T_j = 125^\circ\text{C}$	10	μs
T_j		-40 ... 150	$^\circ\text{C}$	
Inverse diode				
I_F	$T_j = 150^\circ\text{C}$	$T_c = 25^\circ\text{C}$	117	A
		$T_c = 80^\circ\text{C}$	81	A
I_{Fnom}		75	A	
I_{FRM}	$I_{FRM} = 2 \times I_{Fnom}$	150	A	
I_{FSM}	$t_p = 10\text{ ms}$, $\sin 180^\circ$, $T_j = 25^\circ\text{C}$	600	A	
T_j		-40 ... 150	$^\circ\text{C}$	
Module				
$I_{t(RMS)}$		600	A	
T_{stg}		-40 ... 125	$^\circ\text{C}$	
V_{isol}	AC sinus 50Hz, $t = 1\text{ min}$	4000	V	

Characteristics						
Symbol	Conditions	min.	typ.	max.	Unit	
IGBT						
$V_{CE(sat)}$	$I_C = 75\text{ A}$ $V_{GE} = 15\text{ V}$ chipelevel	$T_j = 25^\circ\text{C}$	1.7	2.1	V	
		$T_j = 125^\circ\text{C}$	2	2.45	V	
V_{CE0}		$T_j = 25^\circ\text{C}$	1	1.2	V	
		$T_j = 125^\circ\text{C}$	0.9	1.1	V	
r_{CE}	$V_{GE} = 15\text{ V}$	$T_j = 25^\circ\text{C}$	9.3	12.0	$\text{m}\Omega$	
		$T_j = 125^\circ\text{C}$	14.7	18.0	$\text{m}\Omega$	
$V_{GE(th)}$	$V_{GE}=V_{CE}$, $I_C = 3\text{ mA}$	5	5.8	6.5	V	
I_{CES}	$V_{GE} = 0\text{ V}$ $V_{CE} = 1200\text{ V}$	$T_j = 25^\circ\text{C}$	0.1	0.3	mA	
		$T_j = 125^\circ\text{C}$			mA	
C_{ies}	$V_{CE} = 25\text{ V}$ $V_{GE} = 0\text{ V}$	$f = 1\text{ MHz}$	5.3		nF	
C_{oes}		$f = 1\text{ MHz}$	0.28		nF	
C_{res}		$f = 1\text{ MHz}$	0.24		nF	
Q_G	$V_{GE} = -8\text{ V...}+15\text{ V}$		600		nC	
R_{Gint}	$T_j = 25^\circ\text{C}$		10.00		Ω	
$t_{d(on)}$	$V_{CC} = 600\text{ V}$ $I_C = 75\text{ A}$	$T_j = 125^\circ\text{C}$	225		ns	
t_r		$T_j = 125^\circ\text{C}$	40		ns	
E_{on}	$R_{Gon} = 2\ \Omega$	$T_j = 125^\circ\text{C}$	10		mJ	
$t_{d(off)}$	$R_{Goff} = 2\ \Omega$	$T_j = 125^\circ\text{C}$	470		ns	
t_f		$T_j = 125^\circ\text{C}$	85		ns	
E_{off}		$T_j = 125^\circ\text{C}$	11		mJ	
$R_{th(j-c)}$	per IGBT			0.27	K/W	

SEMiX101GD126HDs



SEMiX® 13

Trench IGBT Modules

SEMiX101GD126HDs

Features

- Homogeneous Si
- Trench = Trenchgate technology
- $V_{CE(sat)}$ with positive temperature coefficient
- High short circuit capability
- UL recognised file no. E63532

Typical Applications*

- AC inverter drives
- UPS
- Electronic Welding

Remarks

- Case temperatur limited to $T_C=125^\circ\text{C}$ max.
- Not for new design

Characteristics						
Symbol	Conditions		min.	typ.	max.	Unit
Inverse diode						
$V_F = V_{EC}$	$I_F = 75\text{ A}$ $V_{GE} = 0\text{ V}$ chip	$T_j = 25^\circ\text{C}$		1.6	1.80	V
		$T_j = 125^\circ\text{C}$		1.6	1.8	V
V_{F0}		$T_j = 25^\circ\text{C}$	0.9	1	1.1	V
		$T_j = 125^\circ\text{C}$	0.7	0.8	0.9	V
r_F		$T_j = 25^\circ\text{C}$	6.7	8.0	9.3	m Ω
		$T_j = 125^\circ\text{C}$	9.3	10.7	12.0	m Ω
I_{RRM}	$I_F = 75\text{ A}$	$T_j = 125^\circ\text{C}$		97		A
Q_{rr}	$di/dt_{off} = 2240\text{ A}/\mu\text{s}$	$T_j = 125^\circ\text{C}$		20		μC
E_{rr}	$V_{GE} = -15\text{ V}$ $V_{CC} = 600\text{ V}$	$T_j = 125^\circ\text{C}$		9		mJ
$R_{th(j-c)}$	per diode				0.46	K/W
Module						
L_{CE}				20		nH
$R_{CC'+EE'}$	res., terminal-chip	$T_C = 25^\circ\text{C}$		0.7		m Ω
		$T_C = 125^\circ\text{C}$		1		m Ω
$R_{th(c-s)}$	per module			0.04		K/W
M_s	to heat sink (M5)		3		5	Nm
M_t		to terminals (M6)	2.5		5	Nm
						Nm
w					350	g
Temperatur Sensor						
R_{100}	$T_C=100^\circ\text{C}$ ($R_{25}=5\text{ k}\Omega$)			$493 \pm 5\%$		Ω
$B_{100/125}$	$R_{(T)}=R_{100}\exp[B_{100/125}(1/T-1/T_{100})]$; $T[\text{K}]$;			3550 $\pm 2\%$		K



GD

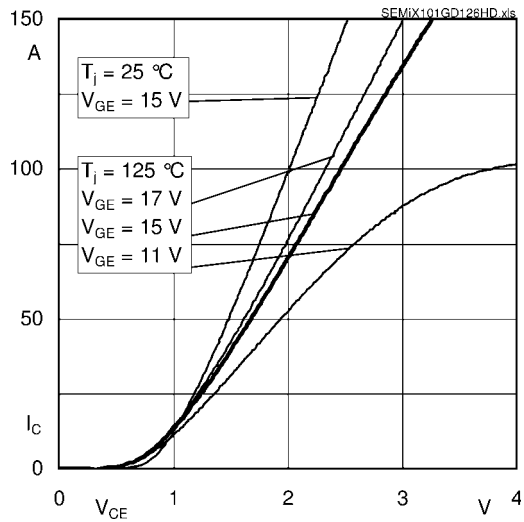

Fig. 1: Typ. output characteristic, inclusive $R_{CC'+EE'}$

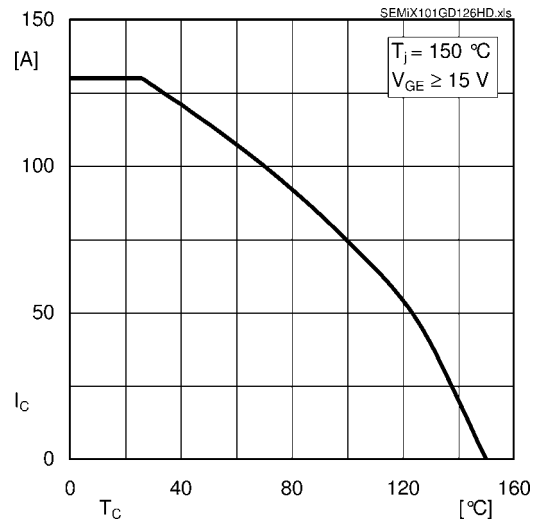

Fig. 2: Rated current vs. temperature $I_C = f(T_C)$

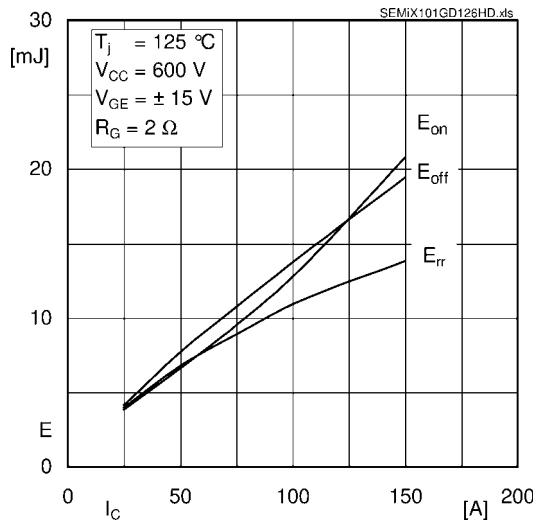

Fig. 3: Typ. turn-on /-off energy = $f(I_C)$

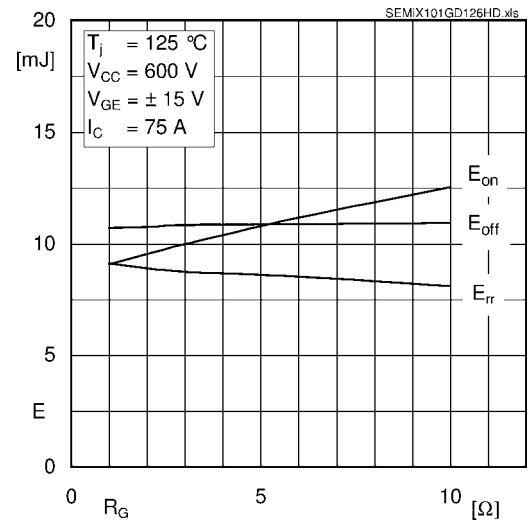

Fig. 4: Typ. turn-on /-off energy = $f(R_G)$

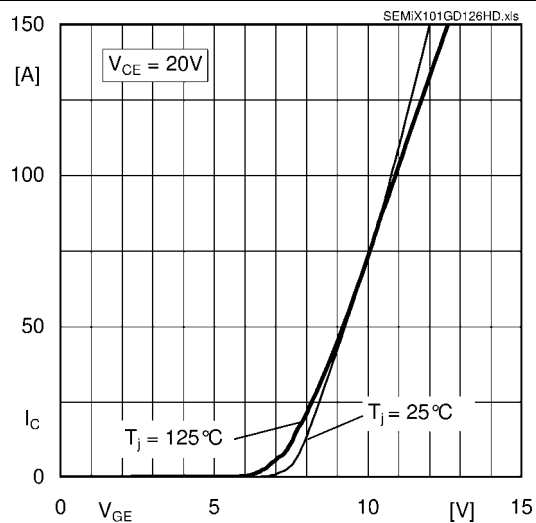

Fig. 5: Typ. transfer characteristic

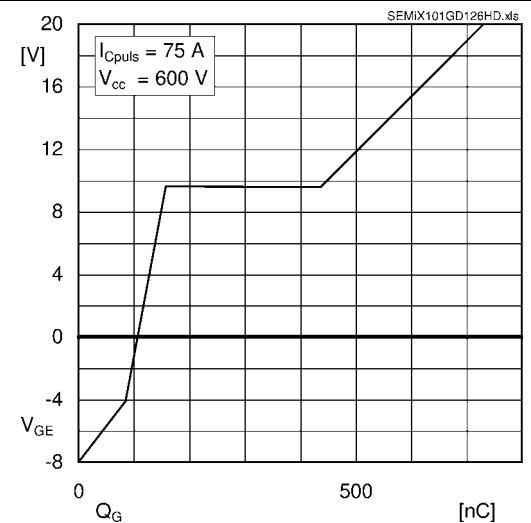
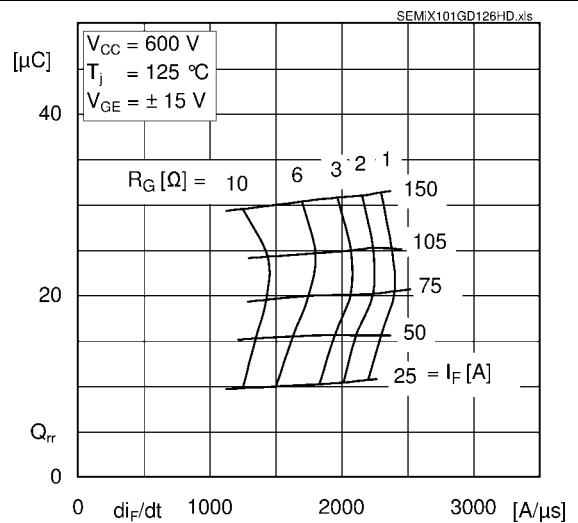
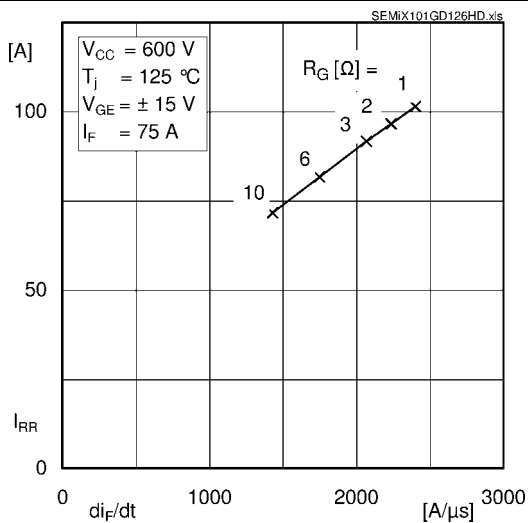
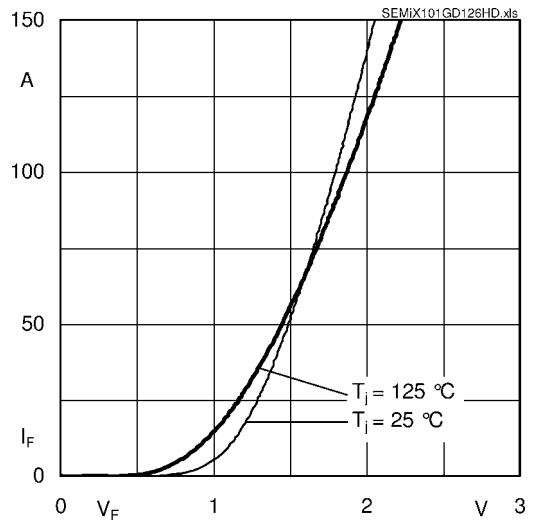
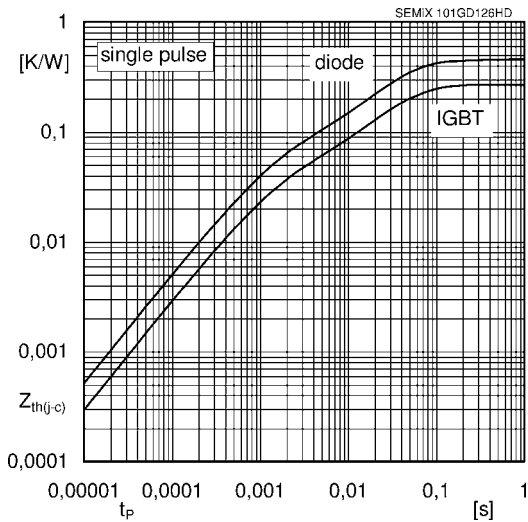
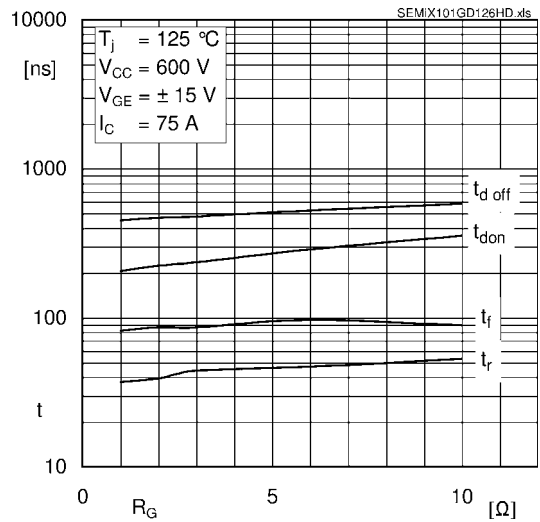
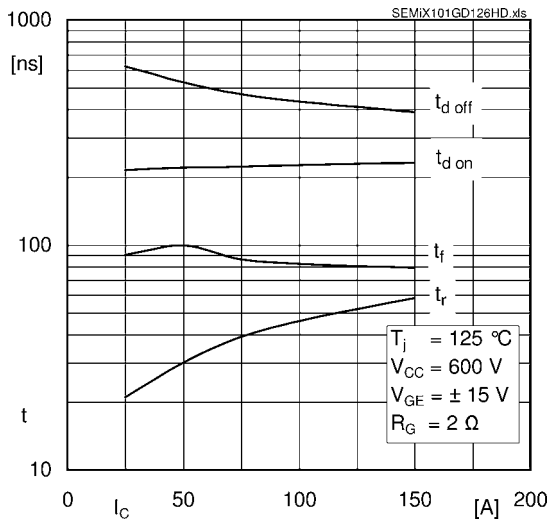
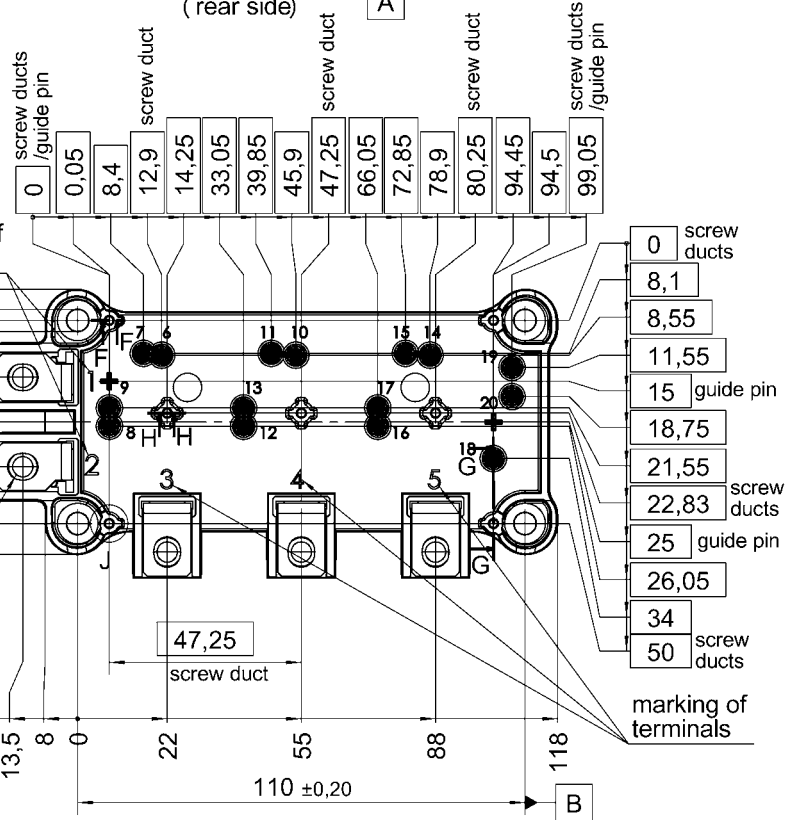
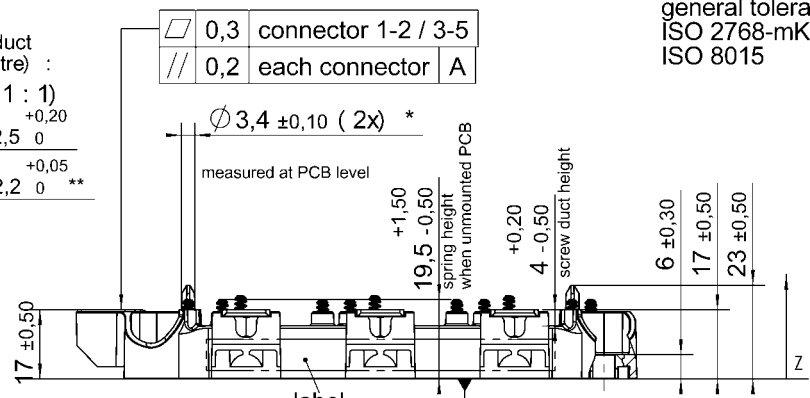
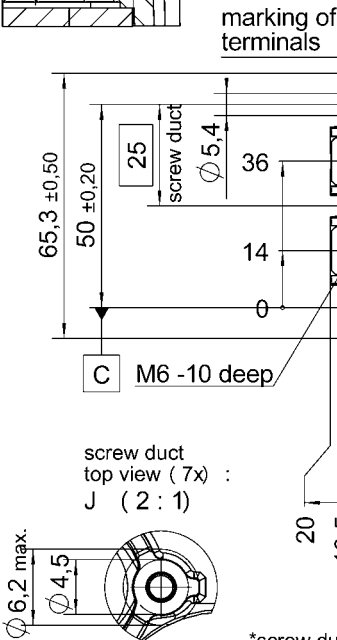
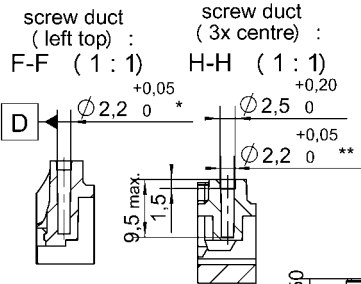

Fig. 6: Typ. gate charge characteristic



SEMiX101GD126HDs

Case: SEMiX 13



*screw duct left / top with $\phi \phi 0,2$ A B C

**screw ducts / guide pins / spring ducts with $\phi \phi 0,2$ A D C

Rules for the contact PCB:

- holes guidepins = $\phi 4 \pm 0,1$ / position tolerance $\pm 0,1$
- holes for screws = $\phi 2,9 \pm 0,1$ / position tolerance $\pm 0,1$
- spring contact pad = $\phi 3,6 \pm 0,1$ / position tolerance $\pm 0,1$

SEMiX 13

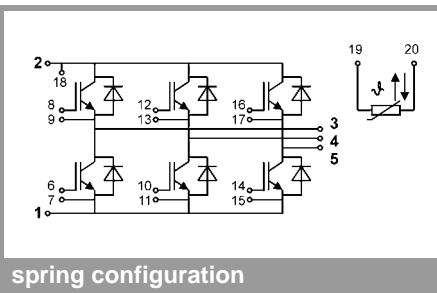

This is an electrostatic discharge sensitive device (ESDS), international standard IEC 60747-1, Chapter IX

* The specifications of our components may not be considered as an assurance of component characteristics. Components have to be tested for the respective application. Adjustments may be necessary. The use of SEMIKRON products in life support appliances and systems is subject to prior specification and written approval by SEMIKRON. We therefore strongly recommend prior consultation of our personal.