

SKM 200GB173D



SEMITRANS® 3

IGBT Modules

SKM 200GB173D

SKM 200GB173D1

SKM 200GAL173D

SKM 200GAR173D

Features

- MOS input (voltage controlled)
- N channel, Homogeneous Si
- Low inductance case
- Very low tail current with low temperature dependence
- High short circuit capability, self limiting to $6 \times I_{Cnom}$
- Latch-up free
- Fast & soft inverse CAL diodes
- Isolated copper baseplate using DCB Direct Copper Bonding Technology
- Large clearance (13 mm) and creepage distance (20 mm)

Typical Applications*

- AC inverter drives on mains 575 - 750 V_{AC}
- DC bus voltage 750 - 1200 V_{DC}
- Public transport (auxiliary syst.)
- Switching (not for linear use)

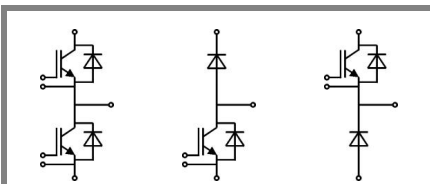

GB

GAL

GAR

Absolute Maximum Ratings		$T_c = 25^\circ\text{C}$, unless otherwise specified		
Symbol	Conditions	Values		Units
IGBT				
V_{CES}	$T_j = 25^\circ\text{C}$	1700		V
I_C	$T_j = 150^\circ\text{C}$	$T_{case} = 25^\circ\text{C}$	220	A
		$T_{case} = 80^\circ\text{C}$	150	A
I_{CRM}	$I_{CRM} = 2 \times I_{Cnom}$	300		A
V_{GES}		± 20		V
t_{psc}	$V_{CC} = 1200\text{ V}; V_{GE} \leq 20\text{ V}; T_j = 125^\circ\text{C}$ $V_{CES} < 1700\text{ V}$	10		µs
Inverse Diode				
I_F	$T_j = 150^\circ\text{C}$	$T_{case} = 25^\circ\text{C}$	150	A
		$T_{case} = 80^\circ\text{C}$	100	A
I_{FRM}	$I_{FRM} = 2 \times I_{Fnom}$	300		A
I_{FSM}	$t_p = 10\text{ ms}; \sin.$	$T_j = 150^\circ\text{C}$	1450	A
Freewheeling Diode				
I_F	$T_j = 150^\circ\text{C}$	$T_{case} = 25^\circ\text{C}$	230	A
		$T_{case} = 80^\circ\text{C}$	150	A
I_{FRM}	$I_{FRM} = 2 \times I_{Fnom}$	400		A
I_{FSM}	$t_p = 10\text{ ms}; \sin$	$T_j = 150^\circ\text{C}$	2200	A
Module				
$I_{t(RMS)}$		500		A
T_{vj}		- 40 ... + 150		°C
T_{stg}		- 40 ... + 125		°C
V_{isol}	AC, 1 min.	4000		V

Characteristics		$T_c = 25^\circ\text{C}$, unless otherwise specified			
Symbol	Conditions	min.	typ.	max.	Units
IGBT					
$V_{GE(th)}$	$V_{GE} = V_{CE}, I_C = 10\text{ mA}$	4,8	5,5	6,2	V
I_{CES}	$V_{GE} = 0\text{ V}, V_{CE} = V_{CES}$		0,1	0,3	mA
V_{CE0}		$T_j = 25^\circ\text{C}$	1,65	1,9	V
		$T_j = 125^\circ\text{C}$	1,9	2,15	V
r_{CE}	$V_{GE} = 15\text{ V}$	$T_j = 25^\circ\text{C}$	11,7	13,3	mΩ
		$T_j = 125^\circ\text{C}$	17,3	19	mΩ
$V_{CE(sat)}$	$I_{Cnom} = 150\text{ A}, V_{GE} = 15\text{ V}$	$T_j = 25^\circ\text{C}_{chiplev.}$	3,4	3,9	V
		$T_j = 125^\circ\text{C}_{chiplev.}$	4,5	5	V
C_{ies}	$V_{CE} = 25, V_{GE} = 0\text{ V}$	$f = 1\text{ MHz}$	20		nF
C_{oes}			2		nF
C_{res}			0,55		nF
Q_G	$V_{GE} = 0\text{V}/+20\text{V}$	2000		nC	
$t_{d(on)}$	$R_{Gon} = 4\ \Omega$	$V_{CC} = 1200\text{V}$ $I_C = 150\text{A}$	580		ns
t_r			100		ns
E_{on}	$R_{Goff} = 4\ \Omega$	$T_j = 125^\circ\text{C}$ $V_{GE} = \pm 15\text{V}$	95		mJ
$t_{d(off)}$			750		ns
t_f			40		ns
E_{off}			45		mJ
$R_{th(j-c)}$	per IGBT			0,1	K/W

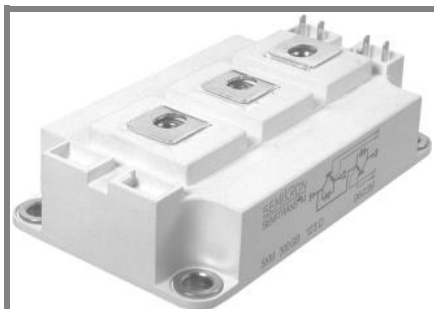

SEMITRANS® 3

IGBT Modules

SKM 200GB173D

SKM 200GB173D1

SKM 200GAL173D

SKM 200GAR173D

Features

- MOS input (voltage controlled)
- N channel , Homogeneous Si
- Low inductance case
- Very low tail current with low temperature dependence
- High short circuit capability, self limiting to $6 \times I_{cnom}$
- Latch-up free
- Fast & soft inverse CAL diodes
- Isolated copper baseplate using DCB Direct Copper Bonding Technology
- Large clearance (13 mm) and creepage distance (20 mm)

Typical Applications*

- AC inverter drives on mains 575 - 750 V_{AC}
- DC bus voltage 750 - 1200 V_{DC}
- Public transport (auxiliary syst.)
- Switching (not for linear use)

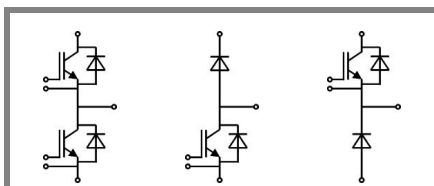

GB

GAL

GAR

Characteristics		min.	typ.	max.	Units
Inverse Diode					
$V_F = V_{EC}$	$I_{Fnom} = 150 \text{ A}; V_{GE} = 0 \text{ V}$	$T_j = 25 \text{ }^\circ\text{C}_{chiplev.}$	2,2	2,7	V
		$T_j = 125 \text{ }^\circ\text{C}_{chiplev.}$	1,9		V
V_{F0}		$T_j = 125 \text{ }^\circ\text{C}$	1,3	1,5	V
r_F		$T_j = 125 \text{ }^\circ\text{C}$	4,5	6,2	mΩ
I_{RRM}	$I_F = 150 \text{ A}$	$T_j = 125 \text{ }^\circ\text{C}$	85		A
Q_{rr}	$di/dt = 1000 \text{ A}/\mu\text{s}$		38		μC
E_{rr}	$V_{GE} = -15 \text{ V}; V_{CC} = 1200 \text{ V}$				mJ
$R_{th(j-c)D}$	per diode			0,32	K/W
FWD					
$V_F = V_{EC}$	$I_{Fnom} = 150 \text{ A}; V_{GE} = 0 \text{ V}$	$T_j = 25 \text{ }^\circ\text{C}_{chiplev.}$	2	2,4	V
		$T_j = 125 \text{ }^\circ\text{C}_{chiplev.}$	1,8		V
V_{F0}		$T_j = 125 \text{ }^\circ\text{C}$	1,3	1,5	V
r_F		$T_j = 125 \text{ }^\circ\text{C}$	3,5	4,5	V
I_{RRM}	$I_F = 150 \text{ A}$	$T_j = 125 \text{ }^\circ\text{C}$	110		A
Q_{rr}			50		μC
E_{rr}	$V_{GE} = -15 \text{ V}; V_{CC} = 1200 \text{ V}$				mJ
$R_{th(j-c)FD}$	per diode			0,21	K/W
Module					
L_{CE}			15	20	nH
$R_{CC+EE'}$	res., terminal-chip	$T_{case} = 25 \text{ }^\circ\text{C}$	0,35		mΩ
		$T_{case} = 125 \text{ }^\circ\text{C}$	0,5		mΩ
$R_{th(c-s)}$	per module			0,038	K/W
M_s	to heat sink M6		3	5	Nm
w				325	g

This is an electrostatic discharge sensitive device (ESDS), international standard IEC 60747-1, Chapter IX.

* The specifications of our components may not be considered as an assurance of component characteristics. Components have to be tested for the respective application. Adjustments may be necessary. The use of SEMIKRON products in life support appliances and systems is subject to prior specification and written approval by SEMIKRON. We therefore strongly recommend prior consultation of our personal.

SKM 200GB173D



SEMITRANS® 3

IGBT Modules

SKM 200GB173D

SKM 200GB173D1

SKM 200GAL173D

SKM 200GAR173D

Features

- MOS input (voltage controlled)
- N channel , Homogeneous Si
- Low inductance case
- Very low tail current with low temperature dependence
- High short circuit capability, self limiting to $6 \times I_{cnom}$
- Latch-up free
- Fast & soft inverse CAL diodes
- Isolated copper baseplate using DCB Direct Copper Bonding Technology
- Large clearance (13 mm) and creepage distance (20 mm)

Typical Applications*

- AC inverter drives on mains 575 - 750 V_{AC}
- DC bus voltage 750 - 1200 V_{DC}
- Public transport (auxiliary syst.)
- Switching (not for linear use)

Z_{th}			
Symbol	Conditions	Values	Units
$Z_{th(j-c)I}$			
$R_{\theta j-c1}$	i = 1	72	mk/W
$R_{\theta j-c2}$	i = 2	19	mk/W
$R_{\theta j-c3}$	i = 3	6,9	mk/W
$R_{\theta j-c4}$	i = 4	2,1	mk/W
τ_{i1}	i = 1	0,0946	s
τ_{i2}	i = 2	0,011	s
τ_{i3}	i = 3	0,0011	s
τ_{i4}	i = 4	0	s
$Z_{th(j-c)D}$			
$R_{\theta j-c1D}$	i = 1	230	mk/W
$R_{\theta j-c2D}$	i = 2	70	mk/W
$R_{\theta j-c3D}$	i = 3	17	mk/W
$R_{\theta j-c4D}$	i = 4	3	mk/W
τ_{i1D}	i = 1	0,0839	s
τ_{i2D}	i = 2	0,0069	s
τ_{i3D}	i = 3	0,0028	s
τ_{i4D}	i = 4	0,0002	s

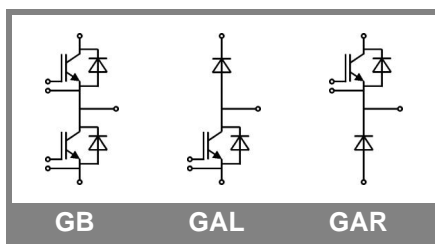

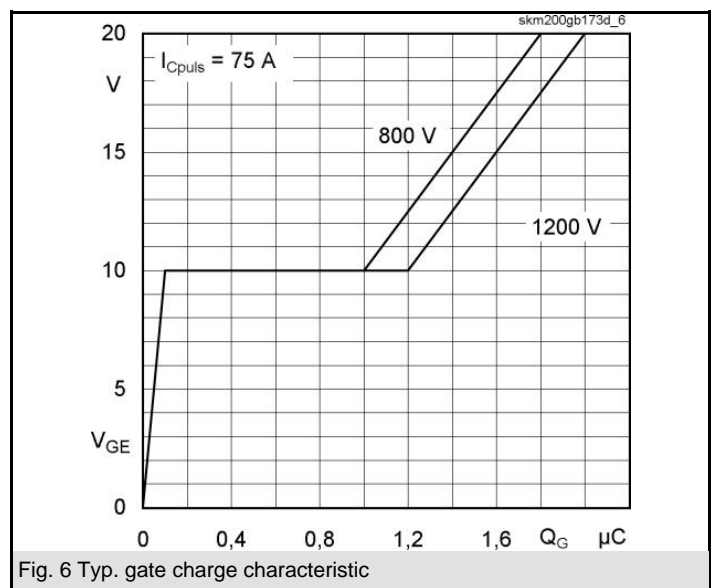
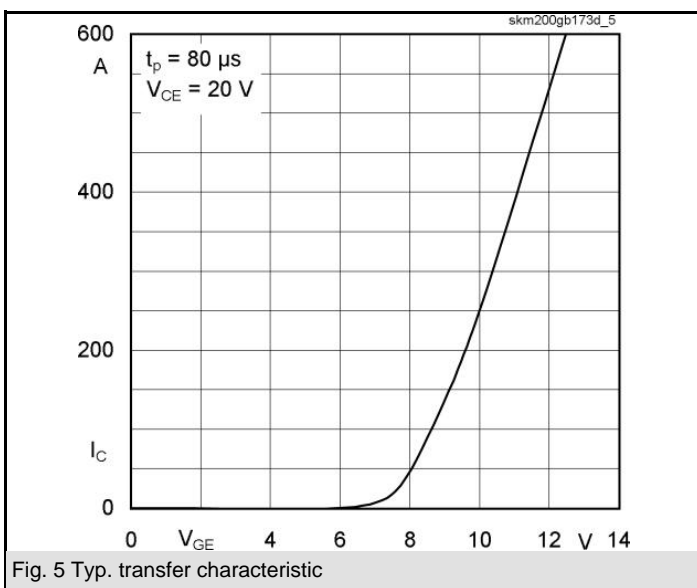
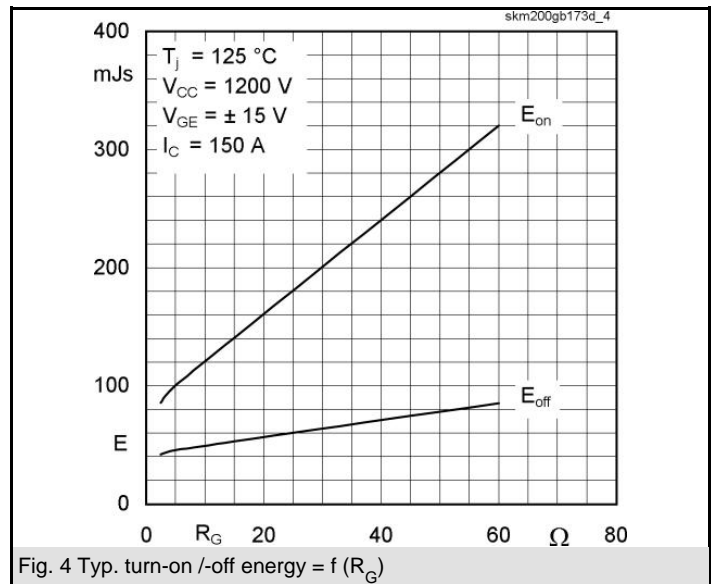
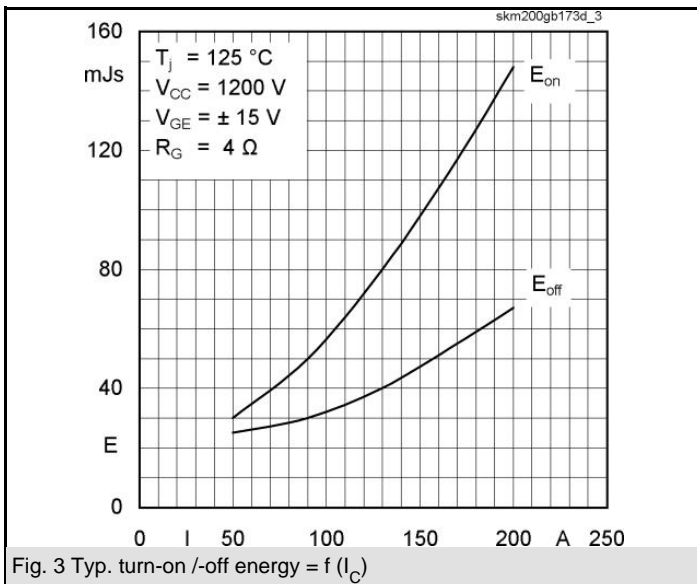
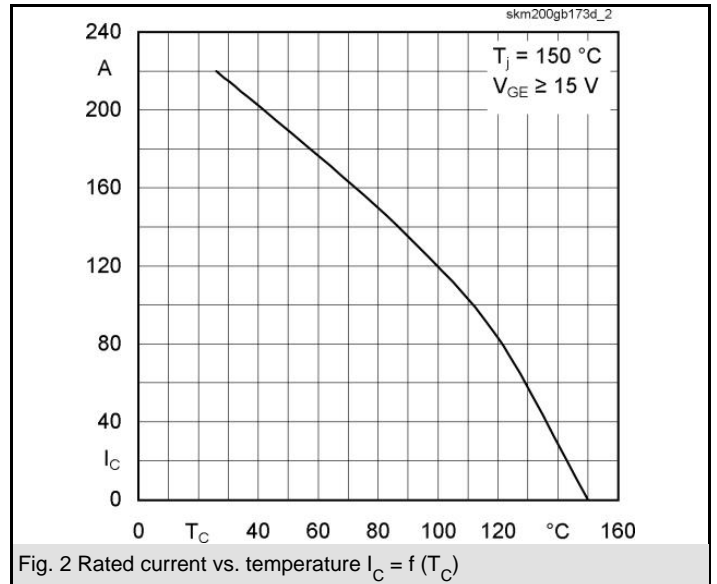
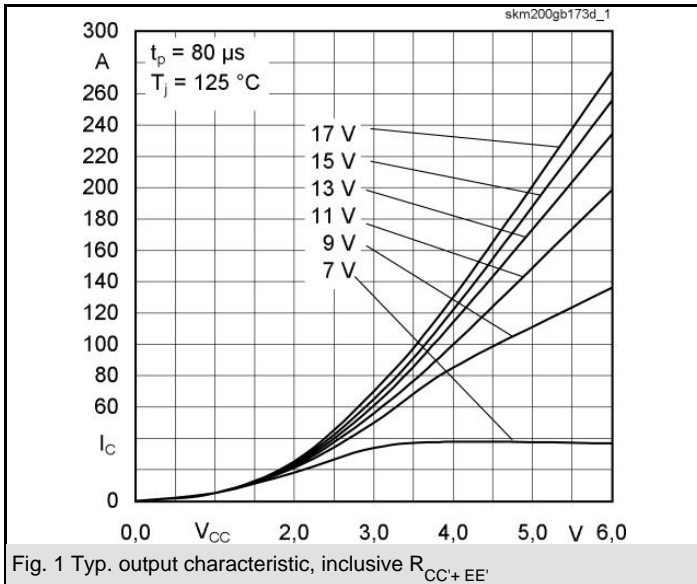

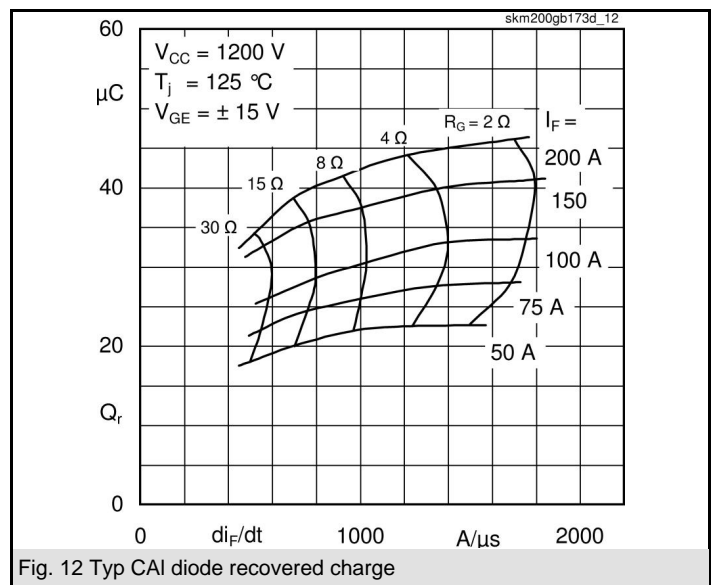
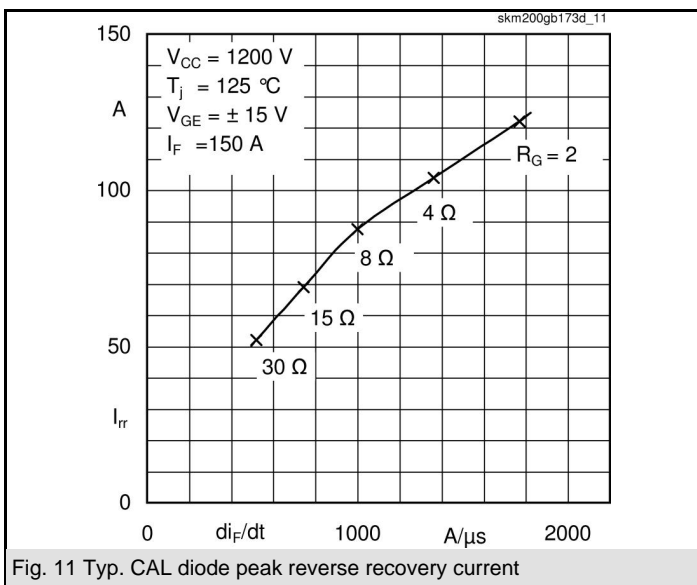
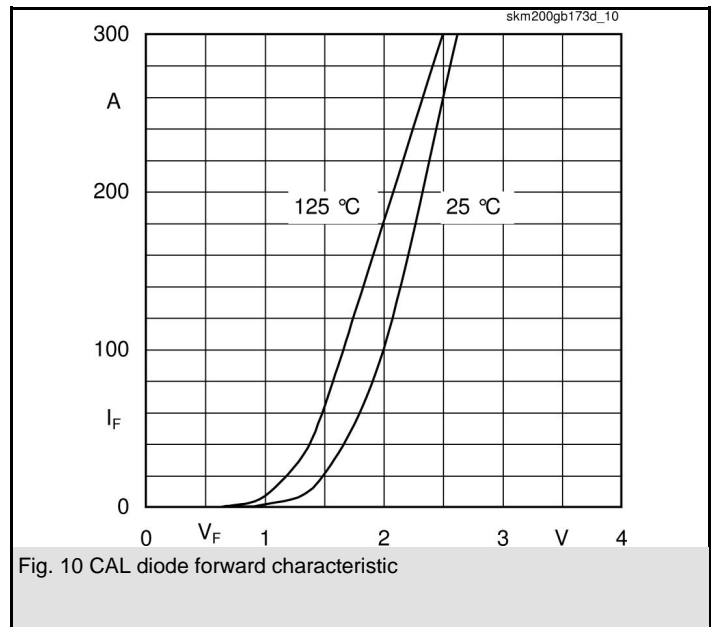
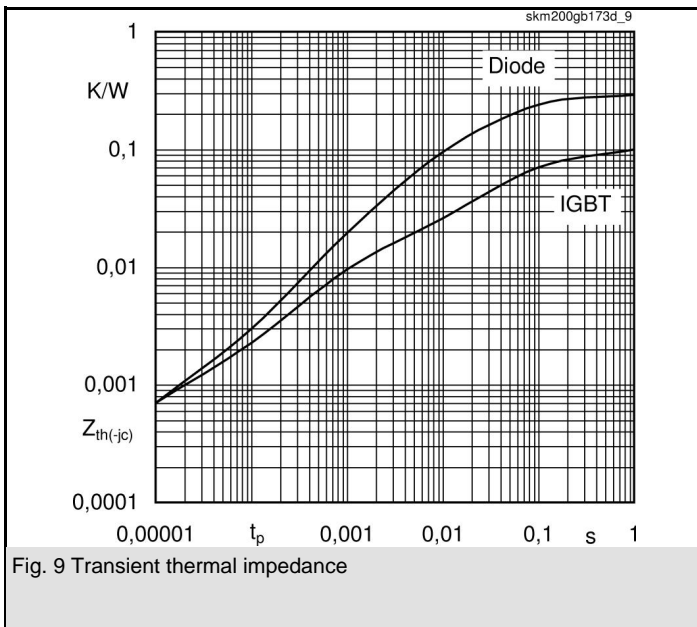
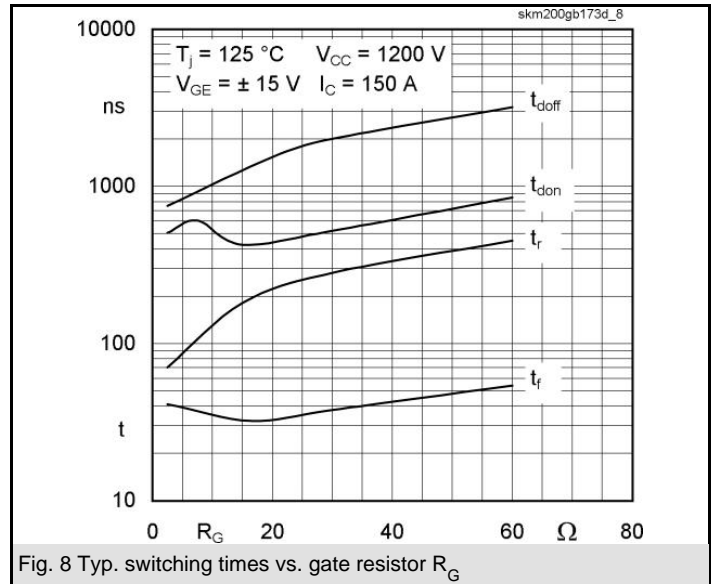
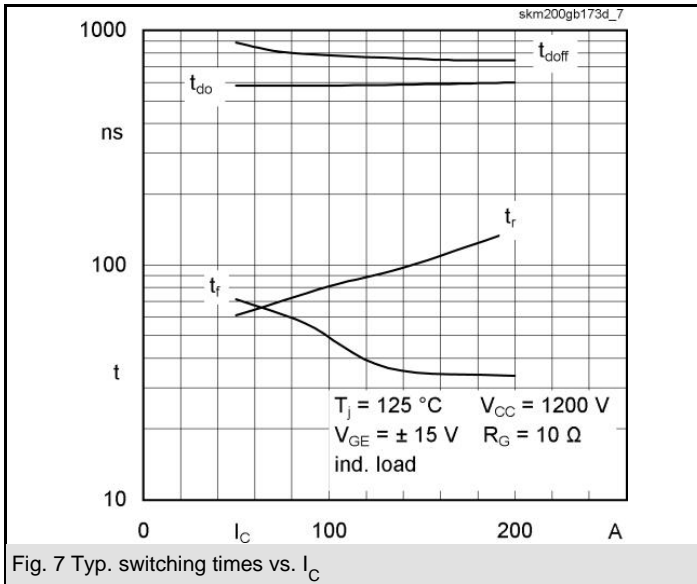

CASED56

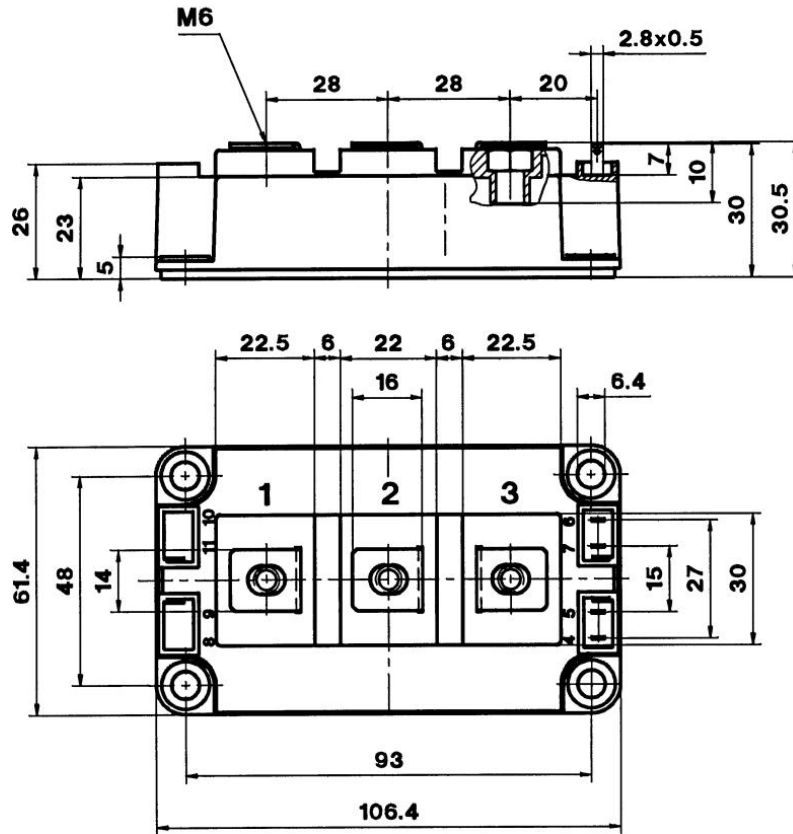

Case D 56

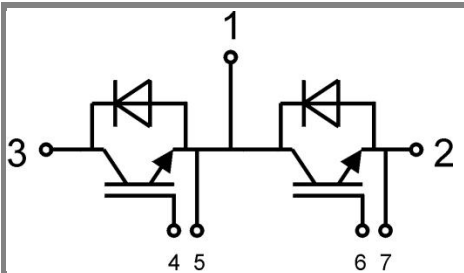

GB

Case D 56

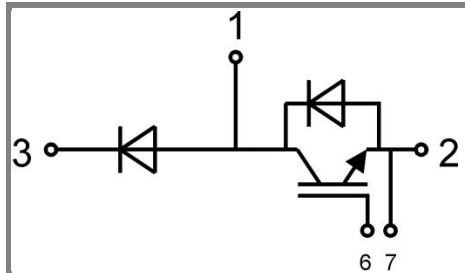

GAL

Case D 57 (→ D 56)

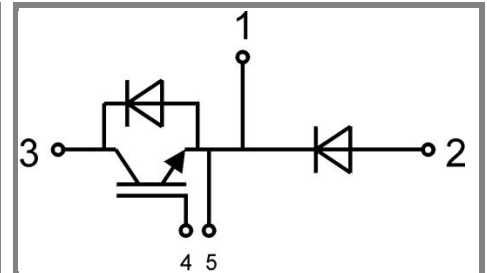

GAR

Case D 58 (→ D 56)